



Max Temp: 55°C
Min. Temp: -40°C

INTRODUCTION:

The Boca NANO X is a very small profile line voltage fixture well suited for coves or task lighting areas where space and energy consumption is constrained. The NANO X is equipped with Boca Flasher's CleanDim® technology ensuring an even dimming from 0-100%. The NANO X can be fabricated with a range of color temperature choices, affording a multitude of options. The housing is plastic resin mold with a durable finish making it temperature and abrasion resistant.

ELECTRICAL SPECIFICATIONS:

1. Input Voltage: 90-120VAC or 220-277VAC
2. Total linear ft per 20A breaker: 225ft (6wplf), 450ft (3wplf)
3. Total linear ft per 15A breaker: 165ft (6wplf), 330ft (3wplf)
4. Input Current: 71mA RMS per linear ft (6wplf), 35mA RMS per linear foot (3wplf)

MAINTENANCE:

Storage:

Store in a dry, well-ventilated area when product is not in use. Keep the electrical cord away from heated surfaces when in use or not in use. If cord shows signs of damage do not use, return product to manufacturer.

Cleaning:

Dry and Damp (IP65) Rated Fixtures:
To clean surface use a soft damp cloth.

Fixtures must be installed by a qualified and licensed electrician in accordance with all national, state and local electrical codes and regulations. If any part of this manual does not meet the necessary codes and regulations, contact the factory for more information before attempting to install.

WARNING: DO NOT LIFT FIXTURE BY CABLES. Do not attempt to install or use the NANO X fixture without reading the installation instructions and safety labels completely.

This could result in permanent damage to both the fixture and the cables. Damage resulting from grasping cables and/or putting undue pressure on the cable connections will not be covered under the warranty!

FAILURE TO ADHERE TO THESE INSTRUCTIONS COULD RESULT IN SERIOUS INJURY OR PROPERTY DAMAGE. DO NOT MODIFY, ALTER OR ATTEMPT TO SERVICE THE NANO X DOING SO WILL VOID THE WARRANTY.

TURN POWER OFF AT CIRCUIT BREAKER BEFORE BEGINNING INSTALLATION!

INCLUDED IN THE PACKAGE:

1. NANOMIX Fixtures, (In lengths shown on job specific drawings)

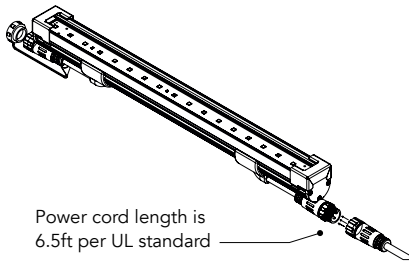

2. Mounting Brackets (2 brackets per fixture)

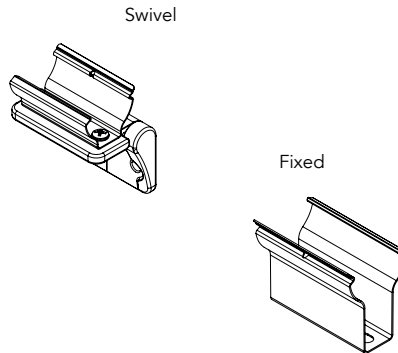

3. Job Specific Drawings

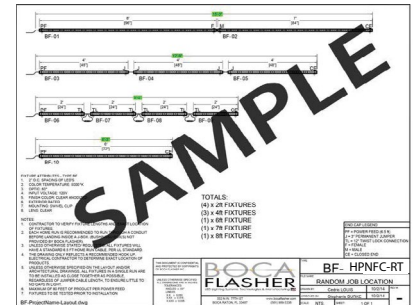

1a: INSTALL CLIPS INTO SUBSTRATE (FIXED SURFACE)

*For vertical installation, please contact the factory for specific mounting instructions.

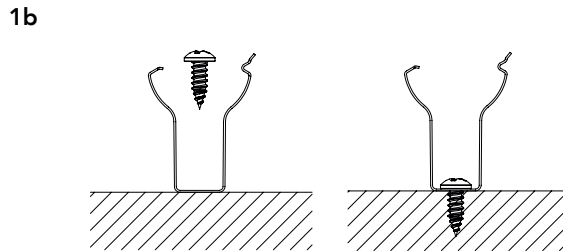
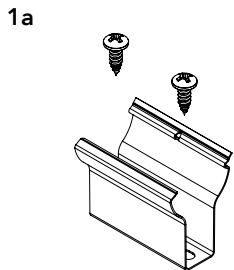

Screw Information:

1. Screws not provided by Boca Flasher.
2. Boca Flasher recommends pan or button head Philips screw. Length of screw will vary depending on mounting surface.

2a. INSTALL FIXTURE INTO CLIPS

2a Clip can widen to take fixture.

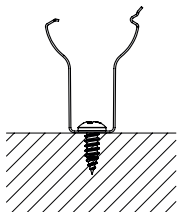

2b Push Fixture down into the clip at an angle with slightly firm pressure.



2c When one corner is inside the clip, turn fixture to "roll" the rest into the clip.

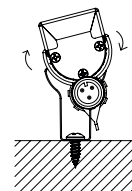

2d Clip will securely snap into place.

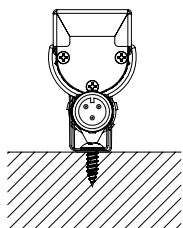

2d Recommended location of the clips, Length of fixture is not relevant.

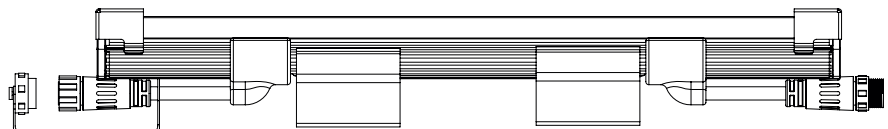

1b. INSTALL CLIPS INTO SUBSTRATE (SWIVEL SURFACE)

*For vertical installation, please contact the factory for specific mounting instructions.

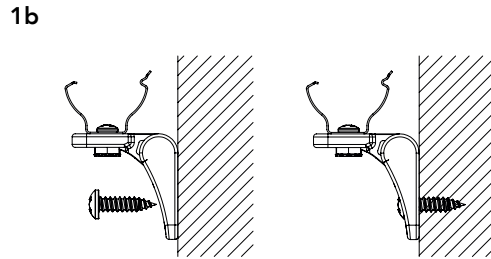
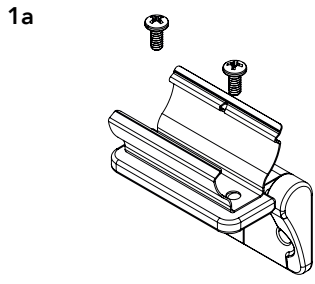

Screw Information:

1. Screws not provided by Boca Flasher.
2. Boca Flasher recommends pan or button head Philips screw. Length of screw will vary depending on mounting surface.

2b. INSTALL FIXTURE INTO CLIPS

2a Clip can widen to take fixture.

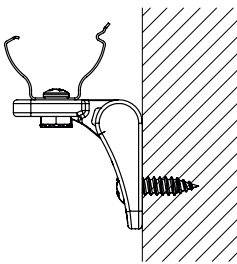

2b Push Fixture down into the clip at an angle with slightly firm pressure.

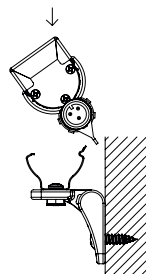

2c When one corner is inside the clip, turn fixture to "roll" the rest into the clip.

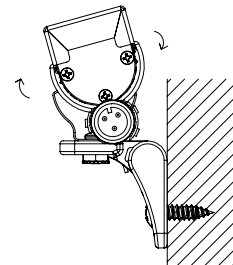

2d Clip will securely snap into place.

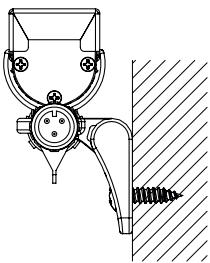

2d Recommended location of the clips, Length of fixture is not relevant.



3. CONNECT FIXTURES TOGETHER RIGID CONNECTION

3a Rotate fixture to see bottom and note each label.

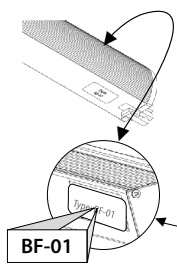

3b Cross-reference with Job Specific Drawing.

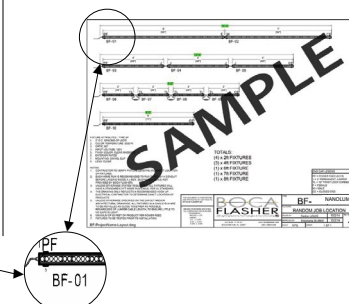

3c Connect Male and Female end caps in order shown on job specific drawings.

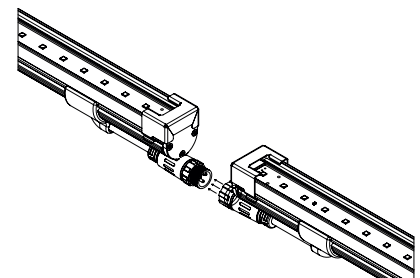

3d Push together until you hear a "CLICK".

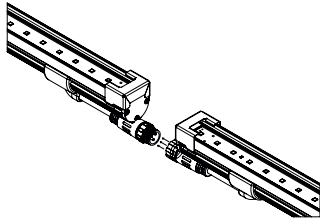

3e When properly installed, NANO WD Rigid connection should result in little to no gap between fixture end caps.

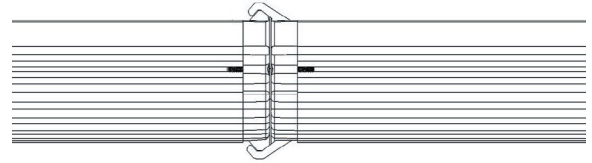

IMPORTANT NOTE: Not screwing fixtures together represents an incomplete install and voids the warranty if any fixtures are damaged as a result of improper installation

4. CONNECT FIXTURES TO POWER

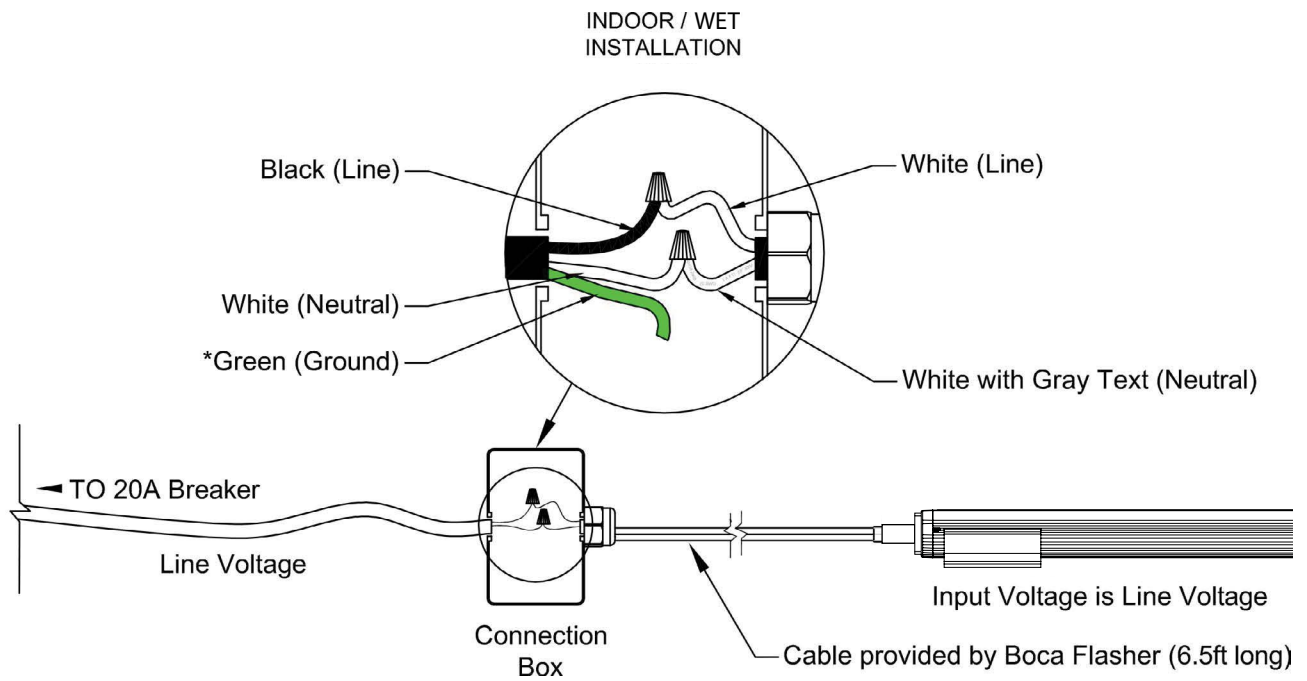

5. CONNECT FIXTURE TO POWER WITH DIMMING SYSTEM

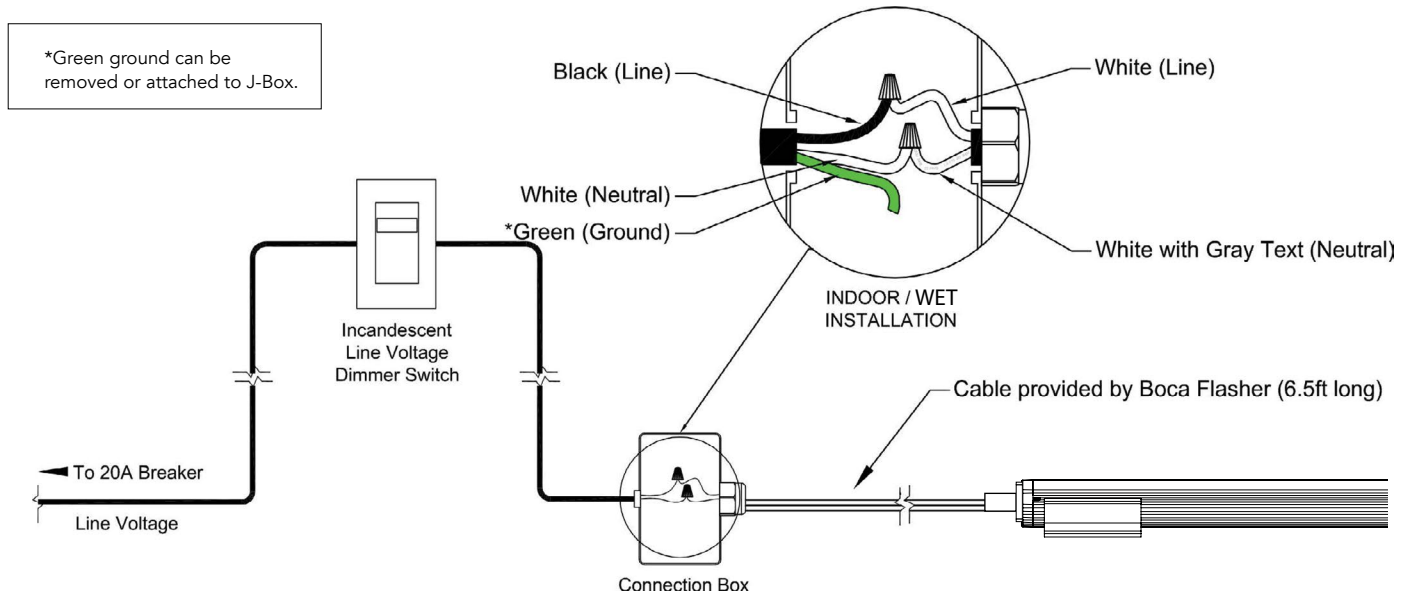

1. DANGER:

To reduce the risk electric shock, always unplug the NANO X from electrical outlet before cleaning. Cut breaker if outlet is not available.

2. To reduce the risk of burns, fire, electric shock or injury to persons:

- Use the NANO X only for its intended use as described in these instructions.
- Do not use attachments not recommended by Boca Flasher.
- Never operate the NANO X if it has a damaged cord, cable or plug, if it is not working properly, if it has been dropped or damaged, or dropped into water. If the seal appears to be damaged/broken/torn return the fixture to a service center for examination or repair.
- Keep cables away from heated surfaces
- Never drop or insert any object into any opening.
- Do not operate where aerosol (spray) products are being used or where oxygen is being administered.

3. WARNING:

- Do not attempt to install or use the NANO X without reading the installation instructions and safety labels.
- Failure to adhere to these instructions could result in serious injury or property damage.

4. Do not modify, alter or attempt to service the NANO X:

- Doing so will void the warranty.

5. There are no serviceable parts within the NANO X:

- Please contact your local representative if issues arise on site during or after installation.

6. Do not use sharp tools near or on the fixture lens:

- Doing so will result in property damage and void the warranty.