



Max Temp: 55°C
Min. Temp: -40°C

INTRODUCTION:

The Boca Niche-HV is a very small profile line voltage fixture well suited to coves or task areas where space and energy consumption are constrained. Boca's CleanDim® technology ensures even dimming from 0-100%. The Boca Flasher Niche-HV can be fabricated with a range of color temperature choices, affording a multitude of options. The housing is clear anodized aluminum with a durable finish making it temperature and abrasion resistant.

ELECTRICAL SPECIFICATIONS:

1. Input Voltage: 90-120VAC
2. Total linear ft per 20A breaker: 165ft (8 wplf), 330ft (4 wplf)
3. Total linear ft per 15A breaker: 125ft (8 wplf), 250ft (4 wplf)
4. Input Current: 95mA RMS per linear ft (8 wplf), 48mA RMS per linear foot (4 wplf)

Fixtures must be installed by a qualified and licensed electrician in accordance with all national, state and local electrical codes and regulations. If any part of this manual does not meet the necessary codes and regulations, contact the factory for more information before attempting to install.

MAINTENANCE:

Storage:

Store in a dry, well-ventilated area when product is not in use. Keep the electrical cord away from heated surfaces when in use or not in use. If cord shows signs of damage do not use, return product to manufacturer.

Cleaning:

Interior (IP50) Rated Fixtures:
To clean surface use a soft damp cloth.

WARNING: DO NOT LIFT FIXTURE BY CABLES. Do not attempt to install or use the NICHE-HV fixture without reading the installation instructions and safety labels completely.

This could result in permanent damage to both the fixture and the cables. Damage resulting from grasping cables and/or putting undue pressure on the cable connections will not be covered under the warranty!

FAILURE TO ADHERE TO THESE INSTRUCTIONS COULD RESULT IN SERIOUS INJURY OR PROPERTY DAMAGE. DO NOT MODIFY, ALTER OR ATTEMPT TO SERVICE THE NICHE-HV DOING SO WILL VOID THE WARRANTY.

TURN POWER OFF AT CIRCUIT BREAKER BEFORE BEGINNING INSTALLATION!

INCLUDED IN THE PACKAGE:

1. NICHE-HV Fixtures, (In lengths shown on job specific drawings)

Rotate Fixture to see label on side.

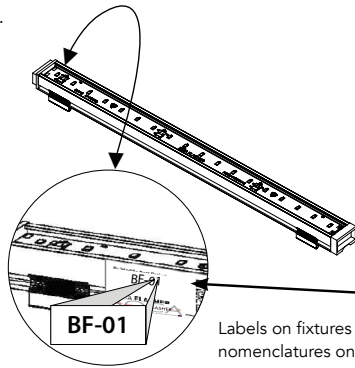

Labels on fixtures correspond with nomenclatures on drawings.

2. Mounting Brackets (2 brackets per fixture)

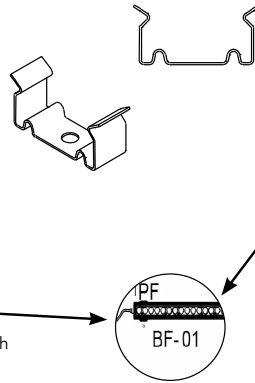

3. Job Specific Drawings

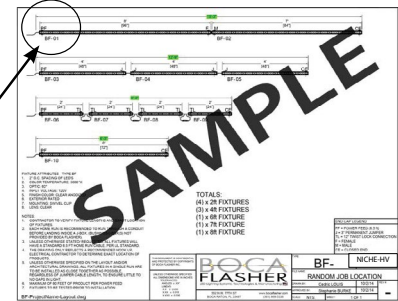

1. INSTALL CLIPS INTO SUBSTRATE

*For vertical installation, please contact the factory for specific mounting instructions.

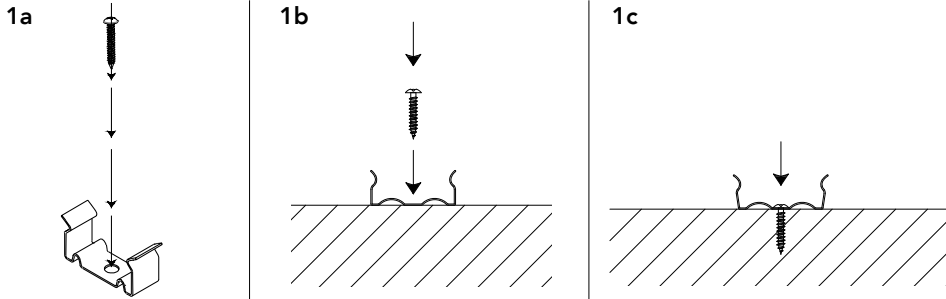

Screw Information:

1. Screws not provided by Boca Flasher.
2. Boca Flasher recommends wide washer flat head Phillips #6 screw. (Not to exceed .1380" in diameter).
3. Length of screw will vary depending on mounting surface.

2. INSTALL FIXTURES INTO CLIPS

2a Push Fixture down with slightly firm pressure.

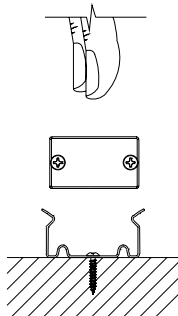

2b Clip will securely snap into place.

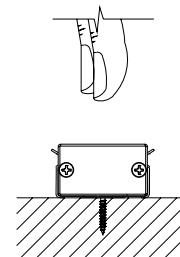

3. CONNECT FIXTURE TO POWER

*Indoor / Dry Installation Only

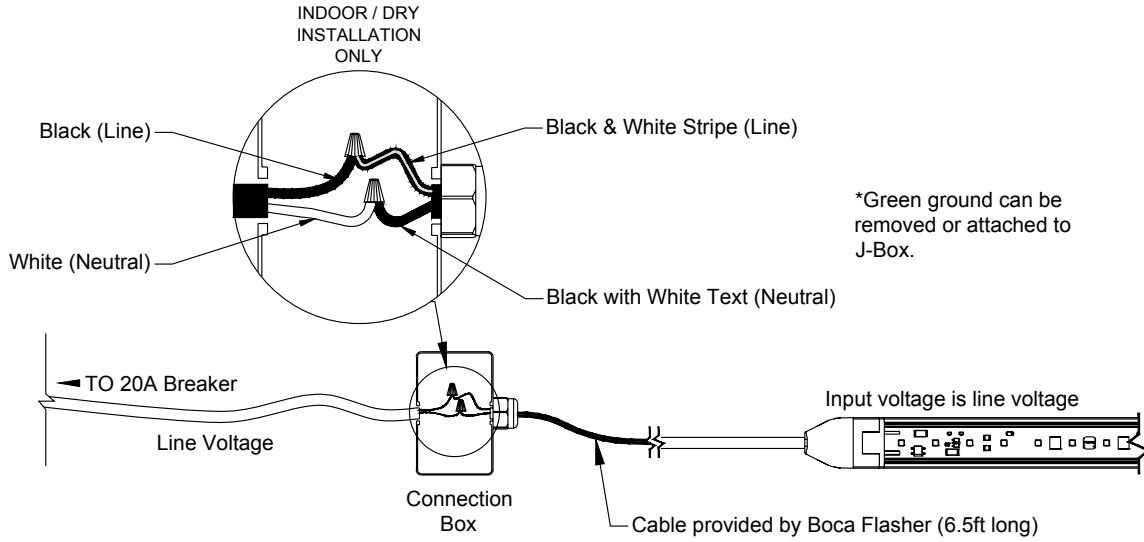

4. CONNECT FIXTURES TO POWER WITH DIMMING SYSTEM

*Indoor / Dry Installation Only

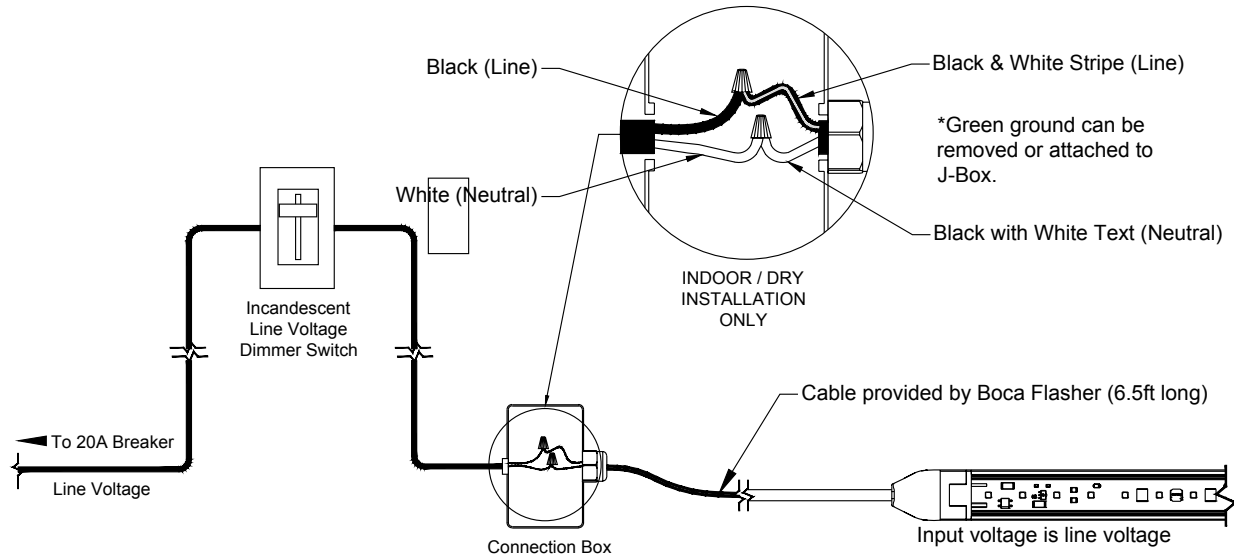

1. DANGER:

To reduce the risk electric shock, always unplug the NICHE-HV from electrical outlet before cleaning.
Cut breaker if outlet is not available.

2. To reduce the risk of burns, fire, electric shock or injury to persons:

- Use the NICHE-HV only for its intended use as described in these instructions.
- Do not use attachments not recommended by Boca Lighting and Cont.
- Never operate the NICHE-HV if it has a damaged cord, cable or plug, if it is not working properly, if it has been dropped or damaged, or dropped into water. If the seal appears to be damaged/broken/torn return the fixture to a service center for examination or repair.
- Keep cables away from heated surfaces
- Never drop or insert any object into any opening.
- Do not operate where aerosol (spray) products are being used or where oxygen is being administered.

3. WARNING:

- Do not attempt to install or use the NICHE-HV without reading the installation instructions and safety labels.
- Failure to adhere to these instructions could result in serious injury or property damage.

4. Do not modify, alter or attempt to service the NICHE-HV:

- Doing so will void the warranty.

5. There are no serviceable parts within the NICHE-HV:

- Please contact your local representative if issues arise on site during or after installation.

6. Do not use sharp tools near or on the fixture lens:

- Doing so will result in property damage and void the warranty.