

Max Temp: 55°C
Min. Temp: -40°C

INTRODUCTION:

Even color washing, also at short distances. 4 Channel allowing use of white or single color additional LED. Compact, variable light fixture for dry and wet location use. Fixture comes in 12", 18", 24", 48" lengths. Many options and accessories to suit a range of projects. Integrates with Boca Wireless DMX Router system for ease of installation and control. Operates with any standard 512 DMX controller. The housing is an anodized aluminum with tempered glass lens for enhanced durability in demanding installations. Contact Boca Flasher for tips with custom installations. Total linear feet per power feed: 40 ft. @ 120V per port. Knife Edge Cove compatible.

ELECTRICAL SPECIFICATIONS:

1. Input Voltage: 90-120VAC or 277VAC
2. Total linear ft per 20A breaker: 225ft (6wplf), 450ft (3wplf)
3. Total linear ft per 15A breaker: 165ft (6wplf), 330ft (3wplf)
4. Input Current: 54mA @ 120V, 24mA @ 277V

MAINTENANCE:

Storage:

Store in a dry, well-ventilated area when product is not in use. Keep the electrical cord away from heated surfaces when in use or not in use. If cord shows signs of damage do not use, return product to manufacturer.

Cleaning:

Interior (IP50) Rated Fixtures:
To clean surface use a soft damp cloth.

Exterior (IP67) Rated Fixtures:
To clean surface use a soft cloth with mild soap and water.

Fixtures must be installed by a qualified and licensed electrician in accordance with all national, state and local electrical codes and regulations. If any part of this manual does not meet the necessary codes and regulations, contact the factory for more information before attempting to install.

WARNING: DO NOT LIFT FIXTURE BY CABLES. Do not attempt to install or use the NANO MIX fixture without reading the installation instructions and safety labels completely.
This could result in permanent damage to both the fixture and the cables. Damage resulting from grasping cables and/or putting undue pressure on the cable connections will not be covered under the warranty!

FAILURE TO ADHERE TO THESE INSTRUCTIONS COULD RESULT IN SERIOUS INJURY OR PROPERTY DAMAGE. DO NOT MODIFY, ALTER OR ATTEMPT TO SERVICE THE NANO X DOING SO WILL VOID THE WARRANTY.

TURN POWER OFF AT CIRCUIT BREAKER BEFORE BEGINNING INSTALLATION!

INCLUDED IN THE PACKAGE:

1. NANO MIX Fixtures, (In lengths shown on job specific drawings)

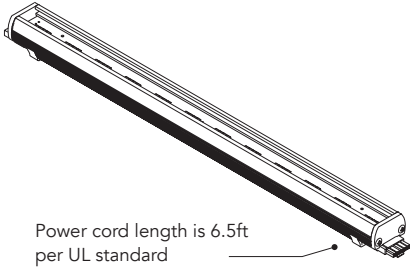

2. Mounting Brackets (2 brackets per fixture)

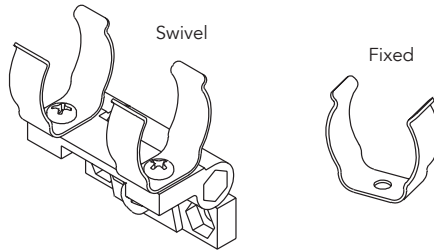

3. Job Specific Drawings

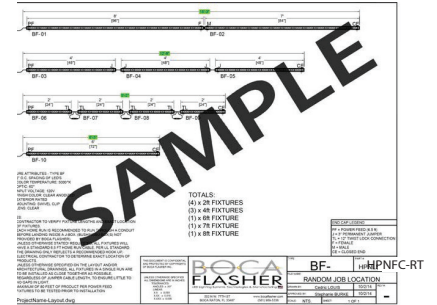

1a: INSTALL CLIPS INTO SUBSTRATE (FIXED SURFACE)

*For vertical installation, please contact the factory for specific mounting instructions.

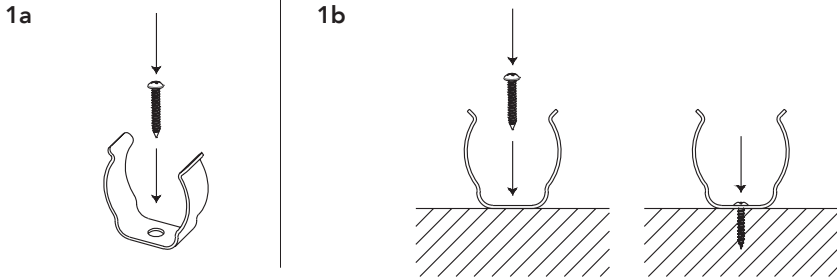

Screw Information:

1. Screws not provided by Boca Flasher.
2. Boca Flasher recommends pan or button head Philips screw. Length of screw will vary depending on mounting surface.

2a. INSTALL FIXTURE INTO CLIPS

2a Clip can widen to take fixture.

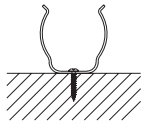

2b Push Fixture down into the clip at an angle with slightly firm pressure.

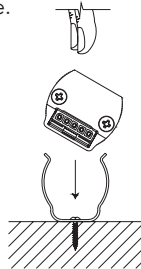

2c When one corner is inside the clip, turn fixture to "roll" the rest into the clip.

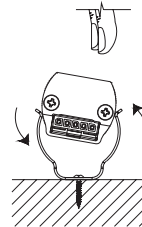

2d Clip will securely snap into place.

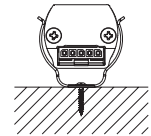

2d Recommended location of the clips, Length of fixture is not relevant.

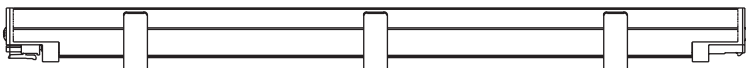

1b. INSTALL CLIPS INTO SUBSTRATE (SWIVEL SURFACE)

*For vertical installation, please contact the factory for specific mounting instructions.

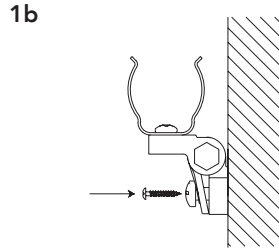
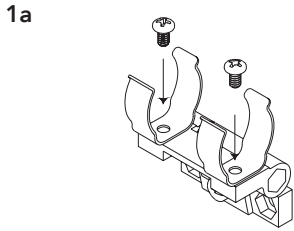

Screw Information:

1. Screws not provided by Boca Flasher.
2. Boca Flasher recommends pan or button head Philips screw. Length of screw will vary depending on mounting surface.

2b. INSTALL FIXTURE INTO CLIPS

2a Clip can widen to take fixture.

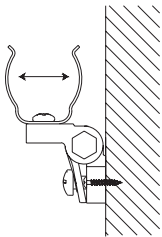

2b Push Fixture down into the clip at an angle with slightly firm pressure.

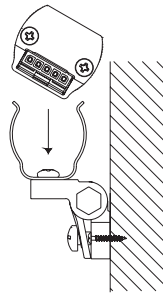

2c When one corner is inside the clip, turn fixture to "roll" the rest into the clip.

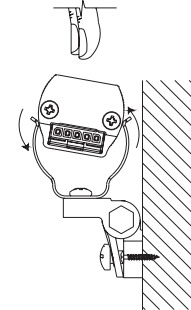

2d Clip will securely snap into place.

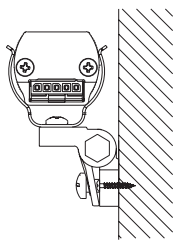

2d Recommended location of the clips, Length of fixture is not relevant.



3. CONNECT FIXTURES TOGETHER RIGID CONNECTION

3a Rotate fixture to see bottom and note each label.

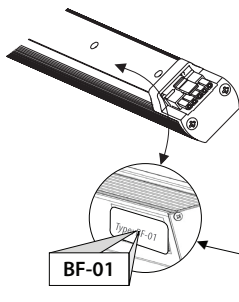

3b Cross-reference with Job Specific Drawing.

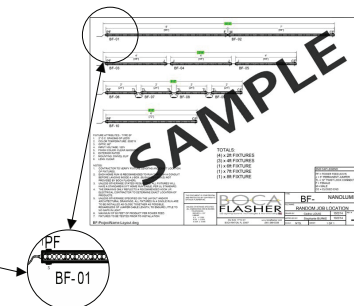

3c Connect Male and Female end caps in order shown on job specific drawings.

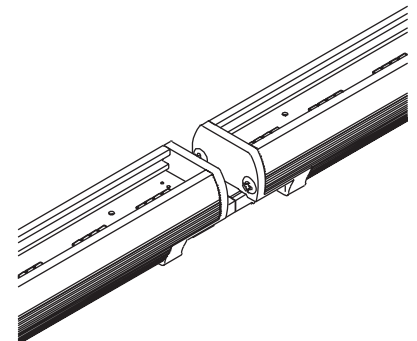

3d Push together until you hear a "CLICK".

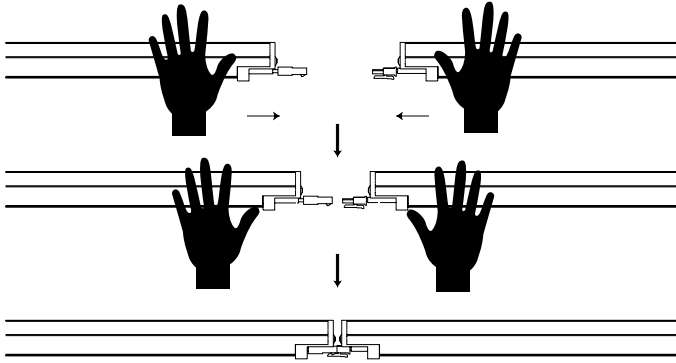

3e When properly installed, NANO MIX Rigid connection should result in little to no gap between fixture end caps.

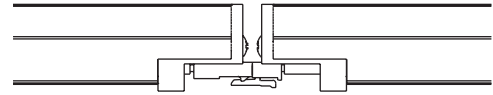

IMPORTANT NOTE: Not screwing fixtures together represents an incomplete install and voids the warranty if any fixtures are damaged as a result of improper installation.

4. CONNECT FIXTURES TO POWER

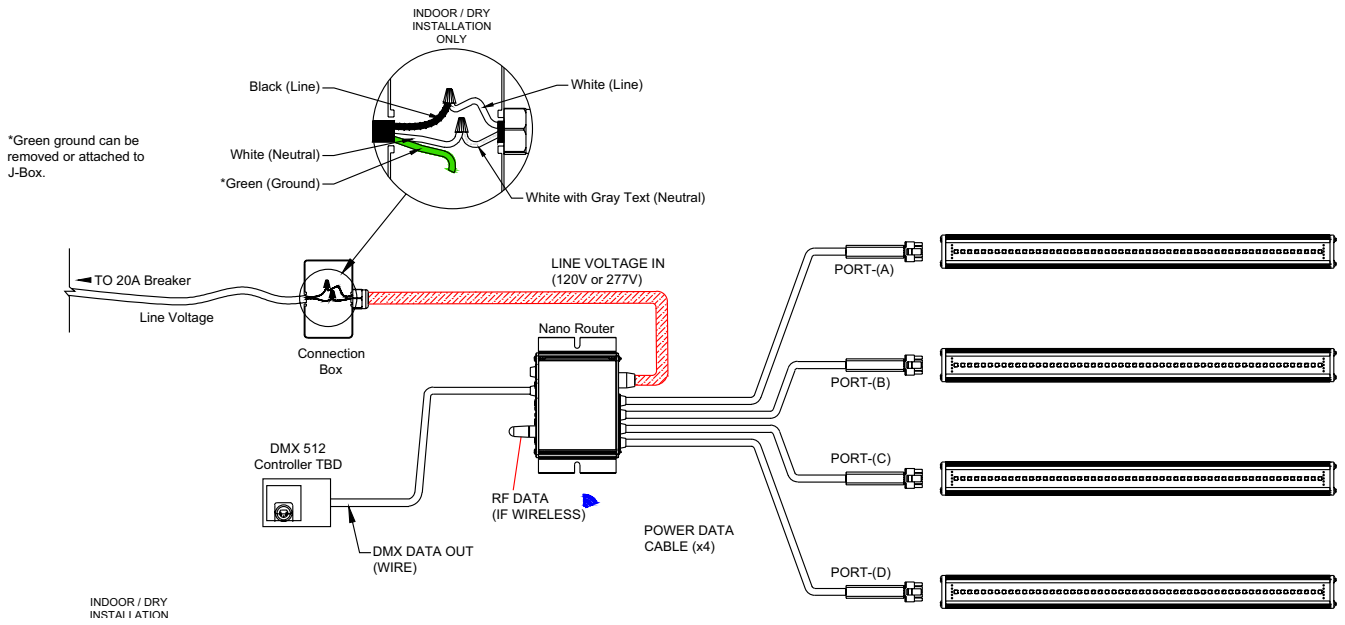

5. CONNECT FIXTURE TO POWER WITH DIMMING SYSTEM

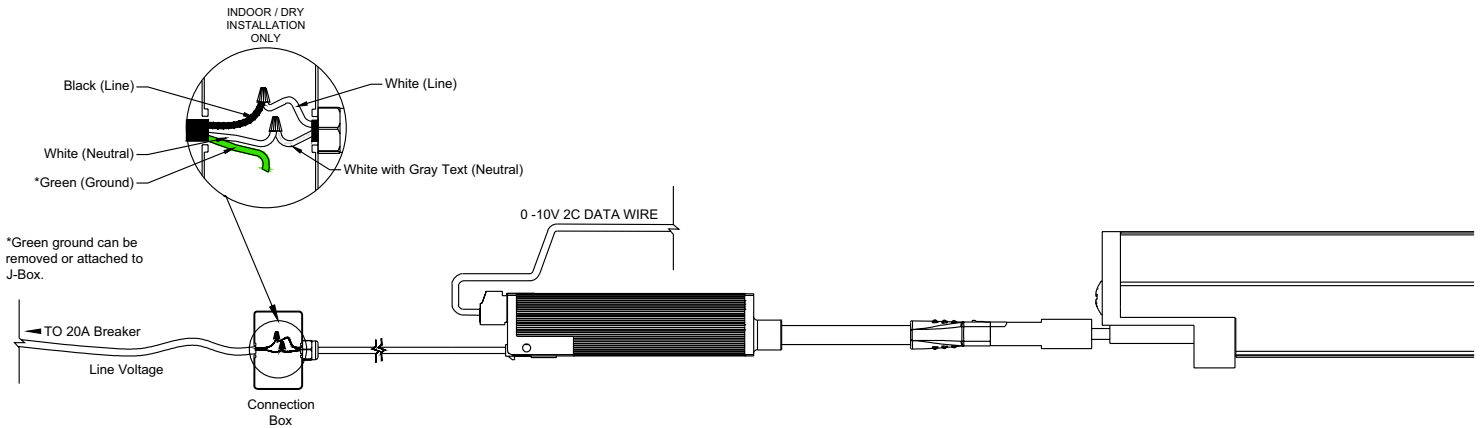

1. DANGER:

To reduce the risk electric shock, always unplug the NANO MIX from electrical outlet before cleaning. Cut breaker if outlet is not available.

2. To reduce the risk of burns, fire, electric shock or injury to persons:

- Use the NANO MIX only for its intended use as described in these instructions.
- Do not use attachments not recommended by Boca Lighting and Controls.
- Never operate the NANO MIX if it has a damaged cord, cable or plug, if it is not working properly, if it has been dropped or damaged, or dropped into water. If the seal appears to be damaged/broken/torn return the fixture to a service center for examination or repair.
- Keep cables away from heated surfaces
- Never drop or insert any object into any opening.
- Do not operate where aerosol (spray) products are being used or where oxygen is being administered.

3. WARNING:

- Do not attempt to install or use the NANO MIX without reading the installation instructions and safety labels.
- Failure to adhere to these instructions could result in serious injury or property damage.

4. Do not modify, alter or attempt to service the NANO MIX:

- Doing so will void the warranty.

5. There are no serviceable parts within the NANO MIX:

- Please contact your local representative if issues arise on site during or after installation.

6. Do not use sharp tools near or on the fixture lens:

- Doing so will result in property damage and void the warranty.