



INTRODUCTION:

The Boca LUMELINE is a line voltage fixture that eliminates the need for secondary transformers, making installation contractor friendly. The housing is anodized aluminum with a durable finish making it weather and abrasion resistant. It is UL Listed for dry, damp or wet location (model dependent). See layout drawings for model provided.

ELECTRICAL SPECIFICATIONS:

1. Input Voltage: 90-120VAC
2. Total linear ft per 20A breaker: 200ft
3. Total linear ft per 15A breaker: 150ft
4. Input Current: Model dependent

Fixtures must be installed by a qualified and licensed electrician in accordance with all national, state and local electrical codes and regulations. If any part of this manual does not meet the necessary codes and regulations, contact the factory for more information before attempting to install.

MAINTENANCE:

Storage:

Store in a dry, well-ventilated area when product is not in use. Keep the electrical cord away from heated surfaces when in use or not in use. If cord shows signs of damage do not use, return product to manufacturer.

Cleaning:

Interior (IP50) Rated Fixtures:
To clean surface use a soft damp cloth.

Exterior (IP67) Rated Fixtures:
To clean surface use a soft cloth with mild soap and water.

WARNING: DO NOT LIFT FIXTURE BY CABLES. Do not attempt to install or use the Lumeline fixture without reading the installation instructions and safety labels completely.
This could result in permanent damage to both the fixture and the cables. Damage resulting from grasping cables and/or putting undue pressure on the cable connections will not be covered under the warranty!
FAILURE TO ADHERE TO THESE INSTRUCTIONS COULD RESULT IN SERIOUS INJURY OR PROPERTY DAMAGE. DO NOT MODIFY, ALTER OR ATTEMPT TO SERVICE THE Lumeline DOING SO WILL VOID THE WARRANTY.

TURN POWER OFF AT CIRCUIT BREAKER BEFORE BEGINNING INSTALLATION!

INCLUDED IN THE PACKAGE:

1. Lumeline Fixtures, (In lengths shown on job specific drawings)

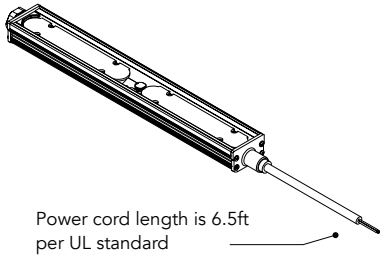

2. Mounting Brackets (2 brackets per fixture)

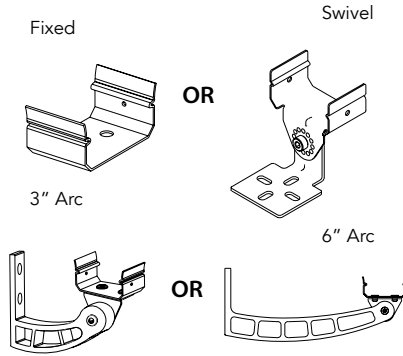

3. Job Specific Drawings

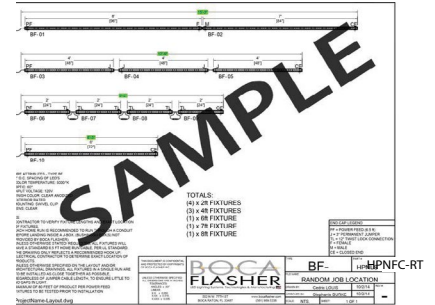

1: INSTALL CLIPS INTO SUBSTRATE

1. Fixed Clips

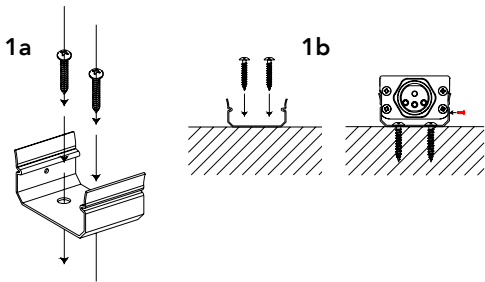

2. Swivel Clips

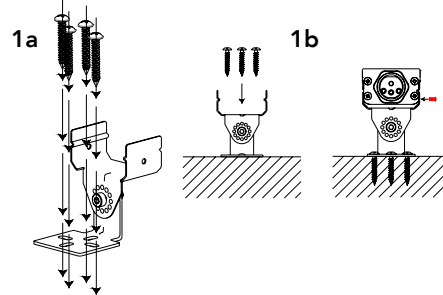

3. 3" Arc and 6" Arc Bracket Installation

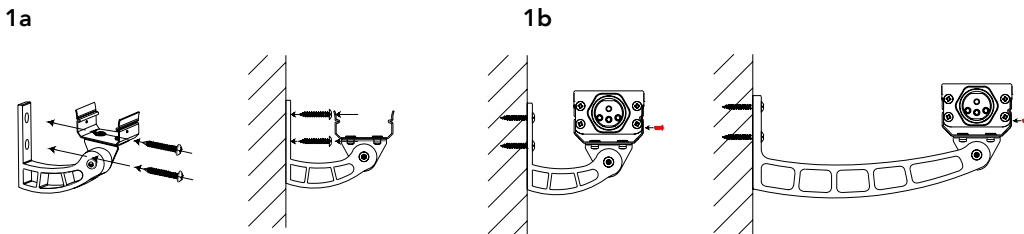

Locking Swivel Bracket:

1. Boca Flasher recommends using an off set Philips screw driver with a #2 bit.
2. Screwdriver should be capable of making a 90° bend.

Screw Information:

1. Screws not provided by Boca Flasher.
2. Boca Flasher recommends wide washer flat head Philips #8 screw (not to exceed .418" in diameter).
3. Length of screw will vary depending on mounting surface.
4. For outdoor installations, installer should use a screw with weatherproof coating.

2. INSTALL FIXTURE INTO CLIPS

2a Place the notch on the clip into the first notch of the fixture.

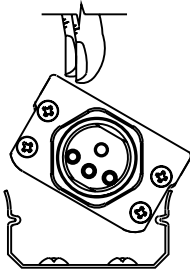

2b Fixture will pivot on notch as it is pushed down.

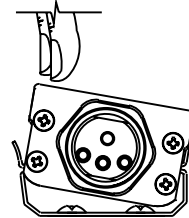

2c Clip will securely snap into place.

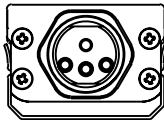

2d If using the Swivel Clip or Arc Bracket loosen the screw where the clip and swivel bracket meet to adjust angle of the fixture.

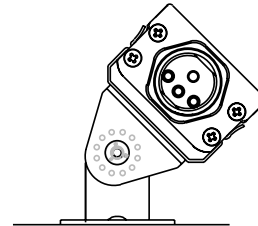

3. CONNECT FIXTURES TOGETHER (AS SHOWN ON JOB SPECIFIC DRAWING)

3a Rotate fixture to see bottom and note each label.

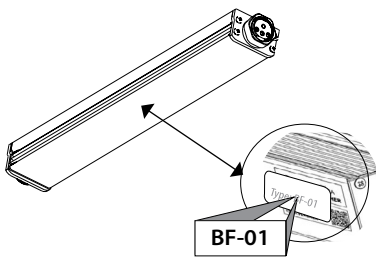

3b Cross-reference with Job Specific Drawing.

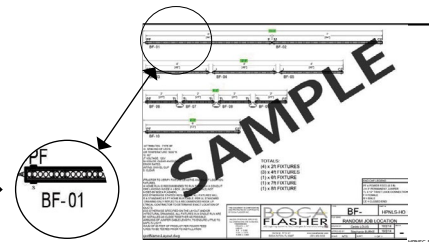

3c Connect Male and Female end caps in order shown on job specific drawings.

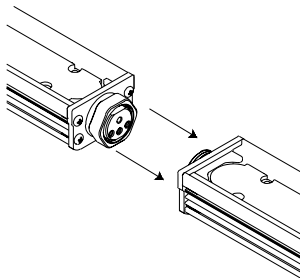

3d Push together then twist until secure.

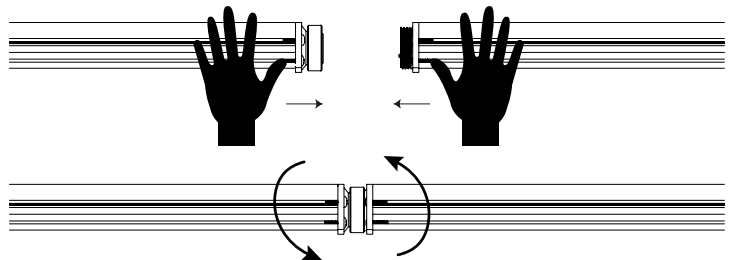

IMPORTANT NOTE: Not screwing fixtures together represents an incomplete install and voids the warranty if any fixtures are damaged as a result of improper installation.

4. CONNECT FIXTURES TOGETHER

4a See above for information on determining layout.

4b Connect Male and Female in order shown on job specific drawings.

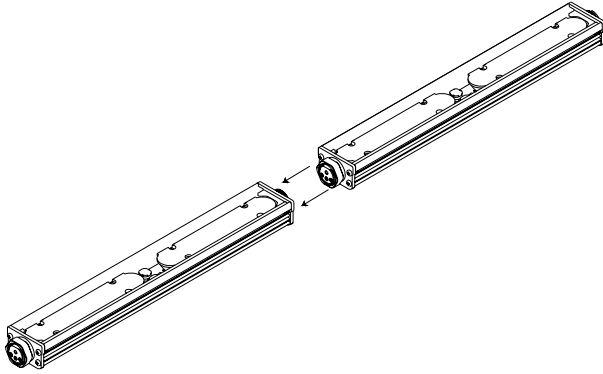

4c Push together and then twist until completely connected and sealed if outdoors.

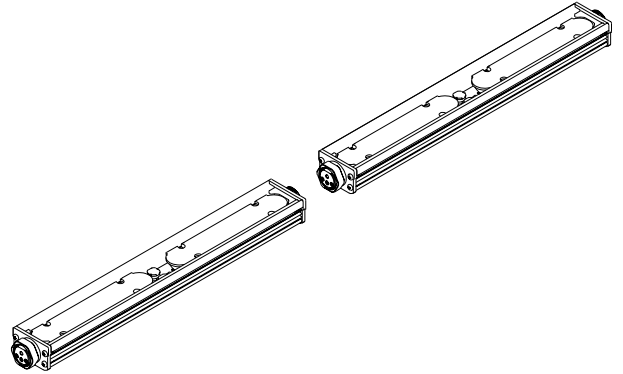

5. CONNECT FIXTURES TO POWER

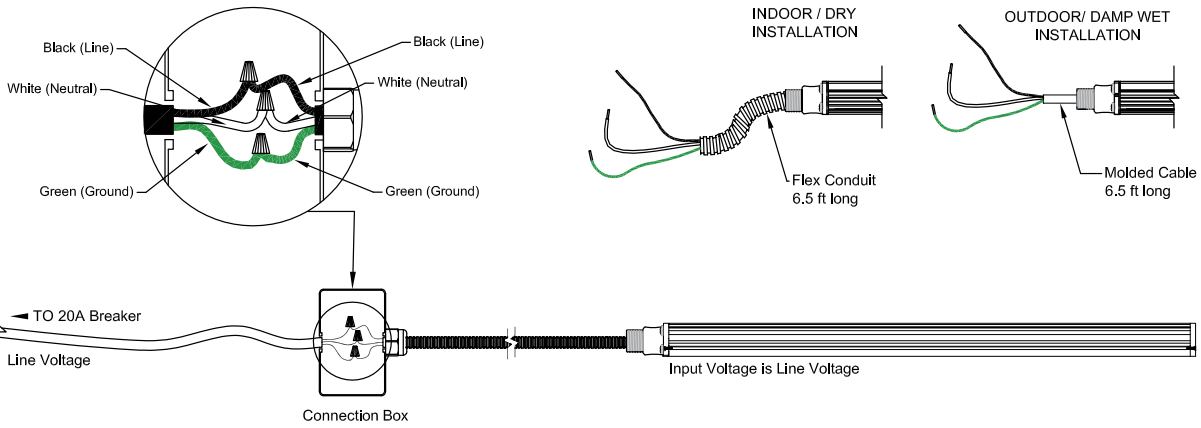

6. CONNECT TO DIMMING SYSTEM

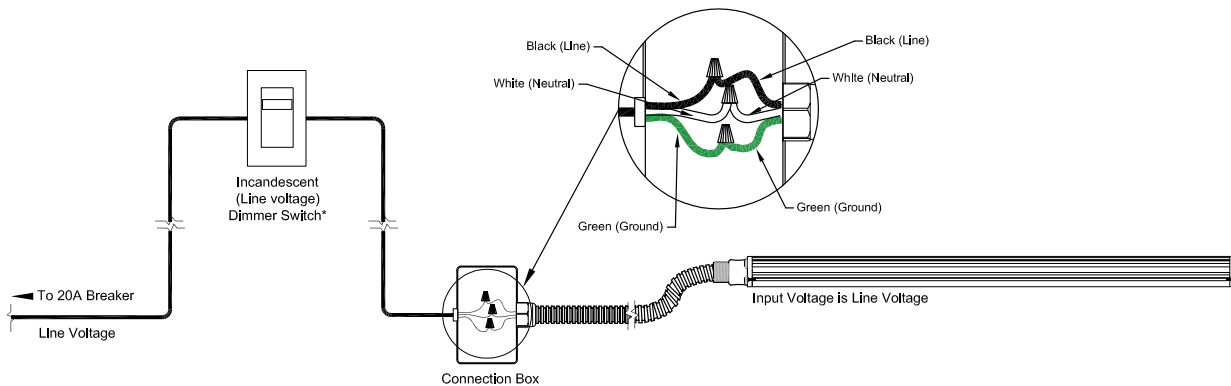

7. REMOVING FIXTURES FROM CLIPS (IF NECESSARY)

7a Slide a flathead screwdriver in between the clip and fixture.

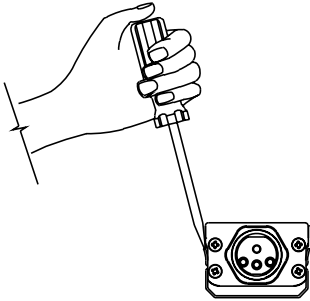

7b While holding the fixture with your other hand, pull back on screwdriver to release from notch.

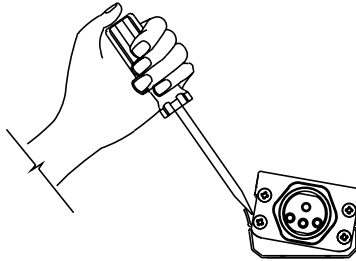

7c Once released from one notch, fixture can be fully removed.

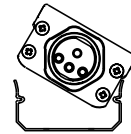

1. DANGER:

To reduce the risk electric shock, always unplug the Lumeline from electrical outlet before cleaning. Cut breaker if outlet is not available.

2. To reduce the risk of burns, fire, electric shock or injury to persons:

- Use the Lumeline only for its intended use as described in these instructions.
- Do not use attachments not recommended by Boca Lighting and Controls.
- Never operate the Lumeline if it has a damaged cord, cable or plug, if it is not working properly, if it has been dropped or damaged, or dropped into water. If the seal appears to be damaged/broken/torn return the fixture to a service center for examination or repair.
- Keep cables away from heated surfaces
- Never drop or insert any object into any opening.
- Do not operate where aerosol (spray) products are being used or where oxygen is being administered.

3. WARNING:

- Do not attempt to install or use the Lumeline without reading the installation instructions and safety labels.
- Failure to adhere to these instructions could result in serious injury or property damage.

4. Do not modify, alter or attempt to service the Lumeline:

- Doing so will void the warranty.

5. There are no serviceable parts within the Lumeline:

- Please contact your local representative if issues arise on site during or after installation.

6. Do not use sharp tools near or on the fixture lens:

- Doing so will result in property damage and void the warranty.