

Max Temp: 55°C
Min. Temp: -40°C

INTRODUCTION:

The popular NANOLUME can now be specified with Boca Flasher’s Dim to Warm technology (NANO WARM DIM). Standard range shifts the color temperature from 3000K to 2000K as the fixture is dimmed. Other color range options are available to meet any project needs. Boca’s patented CleanDim® technology ensures even dimming from 0-100%.

ELECTRICAL SPECIFICATIONS:

1. Input Voltage: 90-120VAC or 220-277VAC
2. Total linear ft per 20A breaker: 210ft (6wplf), 470ft (3wplf)
3. Total linear ft per 15A breaker: 156ft (6wplf), 350ft (3wplf)
4. Input Current: 54mA RMS per linear ft (6wplf), 26mA RMS per linear foot (3wplf)

Fixtures must be installed by a qualified and licensed electrician in accordance with all national, state and local electrical codes and regulations. If any part of this manual does not meet the necessary codes and regulations, contact the factory for more information before attempting to install.

MAINTENANCE:

Storage:

Store in a dry, well-ventilated area when product is not in use. Keep the electrical cord away from heated surfaces when in use or not in use. If cord shows signs of damage do not use, return product to manufacturer.

Cleaning:

Interior (IP50) Rated Fixtures:
To clean surface use a soft damp cloth.

WARNING: DO NOT LIFT FIXTURE BY CABLES. Do not attempt to install or use the NANO WARM DIM fixture without reading the installation instructions and safety labels completely.

This could result in permanent damage to both the fixture and the cables. Damage resulting from grasping cables and/or putting undue pressure on the cable connections will not be covered under the warranty!

FAILURE TO ADHERE TO THESE INSTRUCTIONS COULD RESULT IN SERIOUS INJURY OR PROPERTY DAMAGE. DO NOT MODIFY, ALTER OR ATTEMPT TO SERVICE THE NANOLUME DOING SO WILL VOID THE WARRANTY.

TURN POWER OFF AT CIRCUIT BREAKER BEFORE BEGINNING INSTALLATION!

INCLUDED IN THE PACKAGE:

1. NANOLUME Fixtures, (In lengths shown on job specific drawings)

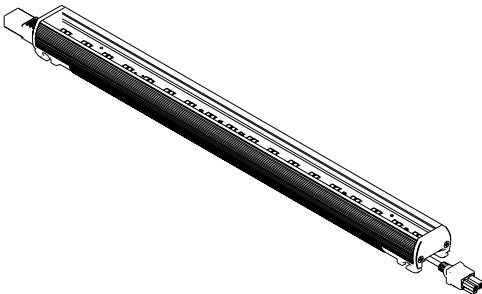

2. Mounting Brackets
(2 clips: 12" - 44" / 3 clips: 48" - 60")

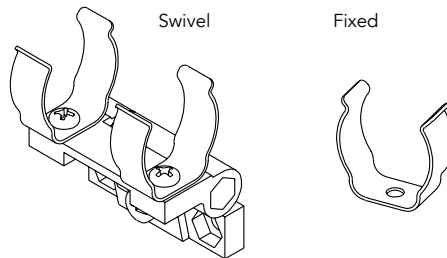

3. Job Specific Drawings

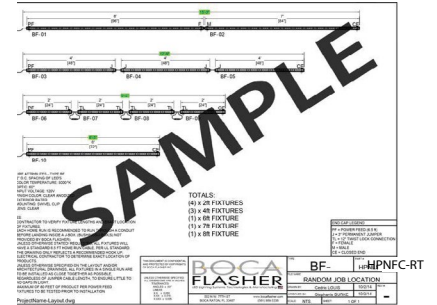

1a. INSTALL CLIPS INTO SUBSTRATE

*For vertical installation, please contact the factory for specific mounting instructions.

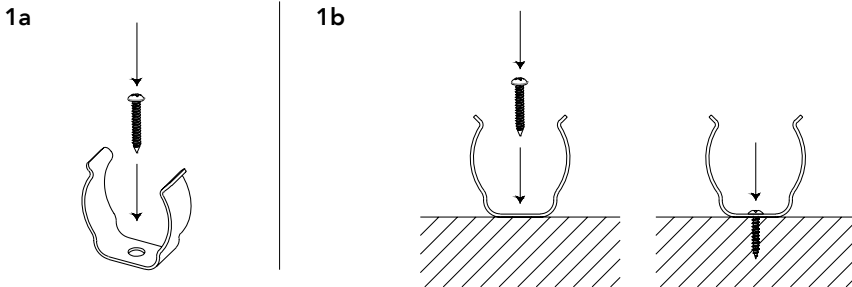

Screw Information:

1. Screws not provided by Boca Flasher.
2. Boca Flasher recommends pan or button head Philips screw. Length of screw will vary depending on mounting surface.

2a. INSTALL FIXTURE INTO CLIPS

2a Clip can widen to take fixture.

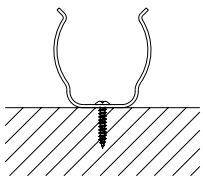

2b Push Fixture down into the clip at an angle with slightly firm pressure.

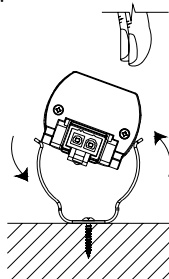

2c When one corner is inside the clip, turn fixture to "roll" the rest into the clip.

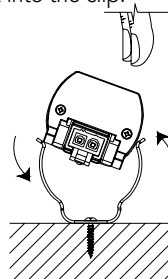

2d Clip will securely snap into place.

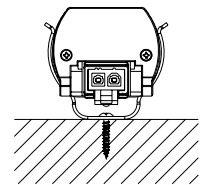

2e Recommended location of the clips, Length of fixture is not relevant.



1b. INSTALL CLIPS INTO SUBSTRATE (SWIVEL SURFACE)

*For vertical installation, please contact the factory for specific mounting instructions.

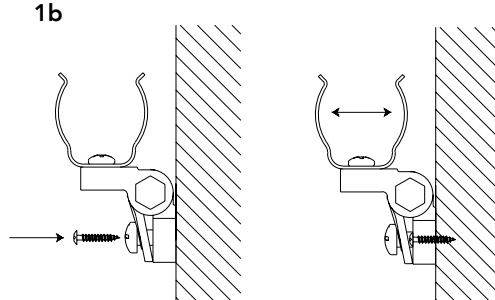
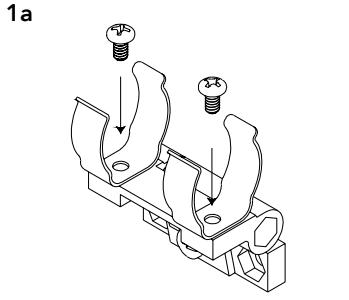

Screw Information:

1. Screws not provided by Boca Flasher.
2. Boca Flasher recommends pan or button head Philips screw. Length of screw will vary depending on mounting surface.

2b. INSTALL FIXTURE INTO CLIPS (SWIVEL SURFACE)

2a Clip can widen to take fixture.

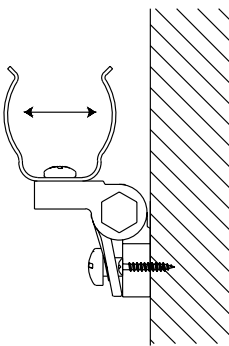

2b Push Fixture down into the clip at an angle with slightly firm pressure.

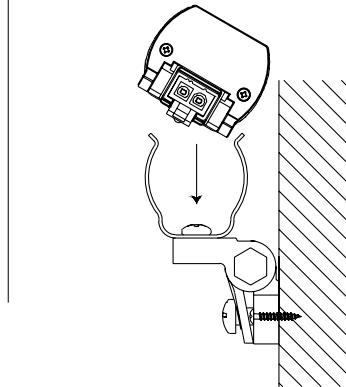

2c When one corner is inside the clip, turn fixture to "roll" the rest into the clip.

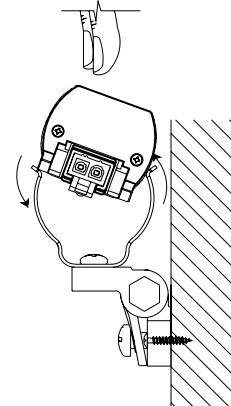

2d Clip will securely snap into place.

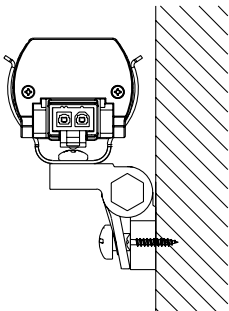

2e Recommended location of the clips, Length of fixture is not relevant.



3. CONNECT FIXTURES TOGETHER

3a Rotate fixture to see bottom and note each label.

Labels on fixtures correspond with nomenclatures on drawings.

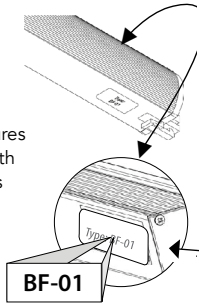

3b Cross-reference with job specific drawing.

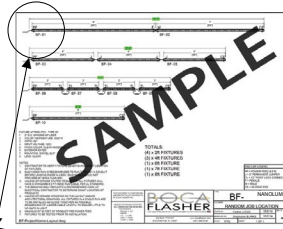

3c Connect Male and Female end caps in order shown on job specific drawings.

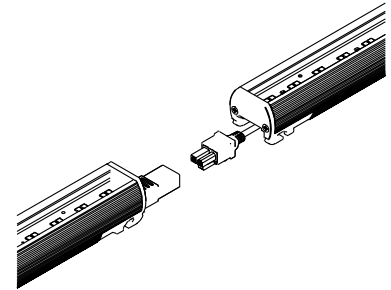

3d Push together until you hear a "click".

"CLICK!"

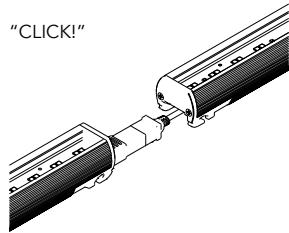

3e When properly installed, NANOLUME connection should result in a little gap between fixture end caps.

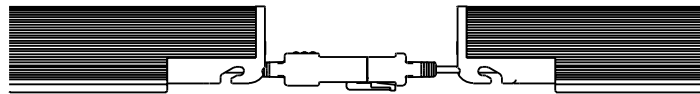

4. CONNECT FIXTURE TO POWER

INDOOR / DRY
INSTALLATION
ONLY

*Green ground can be removed or attached to J-Box.

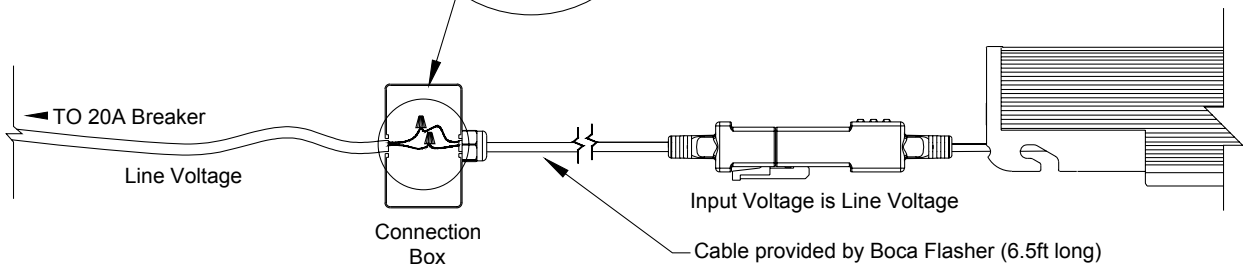
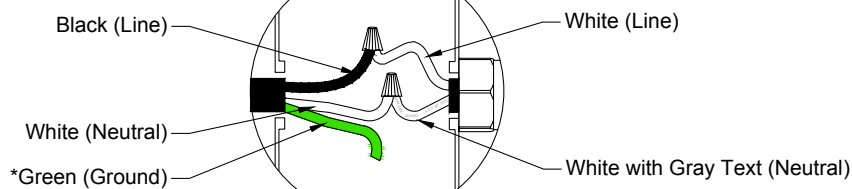

5. CONNECT FIXTURE TO POWER WITH DIMMING SYSTEM

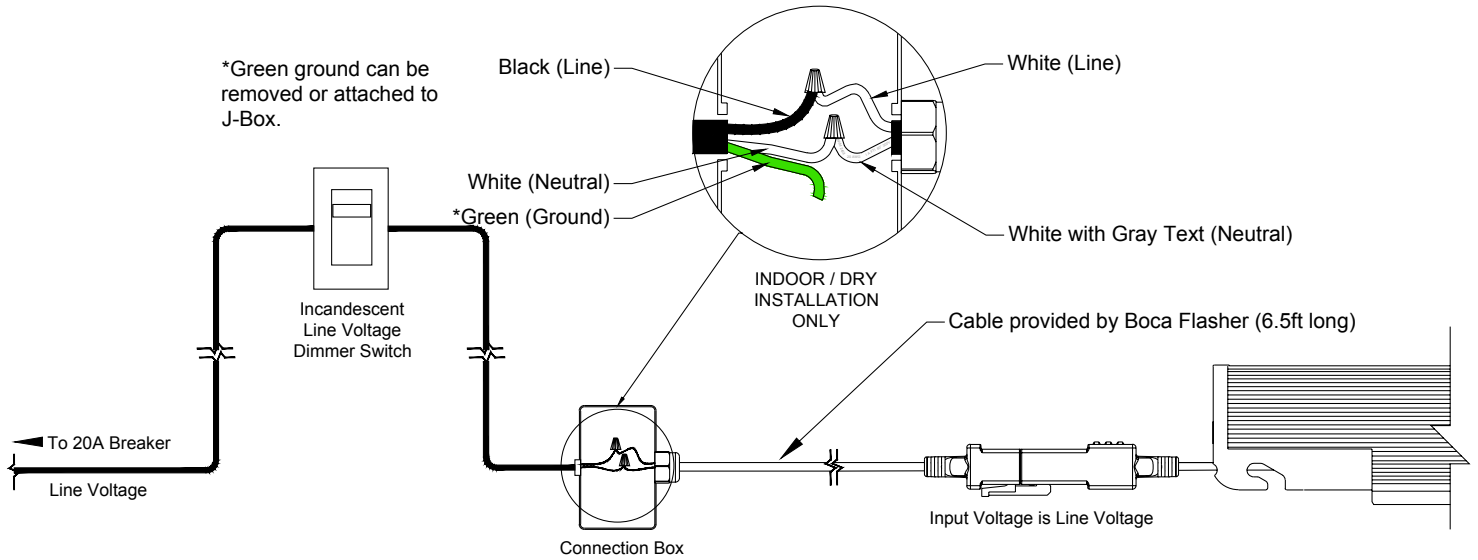

1. DANGER:

To reduce the risk electric shock, always unplug the NANO WARM DIM from electrical outlet before cleaning. Cut breaker if outlet is not available.

2. To reduce the risk of burns, fire, electric shock or injury to persons:

- Use the NANO WARM DIM only for its intended use as described in these instructions.
- Do not use attachments not recommended by Boca Lighting and Controls.
- Never operate the NANO WARM DIM if it has a damaged cord, cable or plug, if it is not working properly, if it has been dropped or damaged, or dropped into water. If the seal appears to be damaged/broken/torn return the fixture to a service center for examination or repair.
- Keep cables away from heated surfaces
- Never drop or insert any object into any opening.
- Do not operate where aerosol (spray) products are being used or where oxygen is being administered.

3. WARNING:

- Do not attempt to install or use the NANO WARM DIM without reading the installation instructions and safety labels.
- Failure to adhere to these instructions could result in serious injury or property damage.

4. Do not modify, alter or attempt to service the NANO WARM DIM:

- Doing so will void the warranty.

5. There are no serviceable parts within the NANO WARM DIM:

- Please contact your local representative if issues arise on site during or after installation.

6. Do not use sharp tools near or on the fixture lens:

- Doing so will result in property damage and void the warranty.