

Max Temp: 55°C
Min. Temp: -40°C

INTRODUCTION:

Boca Flasher's TriLight is perfect for color washing long runs and direct view applications. The TriLights triple diode color mixing process creates an even wash for color mixing. The housing is anodized aluminum and is weather and abrasion resistant.

ELECTRICAL SPECIFICATIONS:

Input Voltage: 24VAC

1. Total linear ft per 20A breaker: 190' for RGB;
2. Total linear ft per 20A breaker: 150' for RGBW
3. Total linear ft per 15A breaker: 140' for RGB;
4. Total linear ft per 15A breaker: 110' for RGBW
5. Input Current: 255.53mA RMS per linear foot for RGB,
6. Input Current: 400.23mA per linear foot for RGBW

Fixtures must be installed by a qualified and licensed electrician in accordance with all national, state and local electrical codes and regulations. If any part of this manual does not meet the necessary codes and regulations, contact the factory for more information before attempting to install.

MAINTENANCE:

Storage:

Store in a dry, well-ventilated area when product is not in use. Keep the electrical cord away from heated surfaces when in use or not in use. If cord shows signs of damage do not use, return product to manufacturer.

Cleaning:

Dry and Damp (IP65) Rated Fixtures:
To clean surface use a soft damp cloth.

Wet (IP68) Rated Fixtures:
To clean surface use a soft cloth with mild soap and water.

WARNING: DO NOT LIFT FIXTURE BY CABLES. Do not attempt to install or use the TRILIGHT fixture without reading the installation instructions and safety labels completely.

This could result in permanent damage to both the fixture and the cables. Damage resulting from grasping cables and/or putting undue pressure on the cable connections will not be covered under the warranty!

FAILURE TO ADHERE TO THESE INSTRUCTIONS COULD RESULT IN SERIOUS INJURY OR PROPERTY DAMAGE. DO NOT MODIFY, ALTER OR ATTEMPT TO SERVICE THE TRILIGHT DOING SO WILL VOID THE WARRANTY.

TURN POWER OFF AT CIRCUIT BREAKER BEFORE BEGINNING INSTALLATION!

INCLUDED IN THE PACKAGE:

1. HPNLS-RT Fixtures, (In lengths shown on job specific drawings)

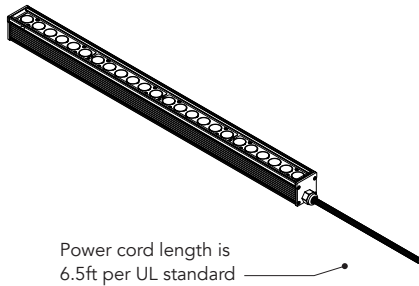

2. Mounting Brackets (2 brackets per fixture)

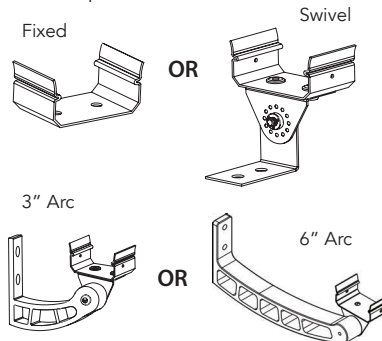

3. Remote Transformers (if ordered)

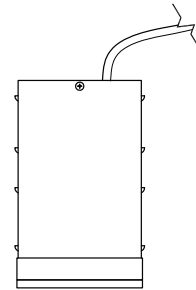

4. I.M.C.S Distribution Box

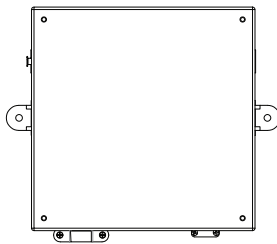

5. Cables

(as shown on layout and packing slips)

6. DMX Controller

(If ordered)

7. Job Specific Drawings

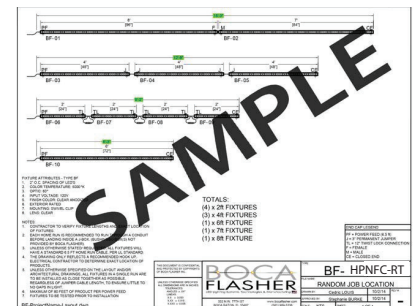

CAUTION: Before installing any type of clip (fixed, swivel or arc) onto the mounting surface determine if the fixtures have rigid or twist lock connections at each end (examples of the rigid and twist lock types are shown in section 4).

INSTALLATION OF CLIPS FOR LIGHT FIXTURES WITH RIGID CONNECTIONS:

1. Light fixtures that have rigid connections on each end must be installed in the same plane and must also be in a straight alignment. Using a chalk line or laser, mark a line on the flat surface where the clips are to be mounted. Align each clip to the chalk line using the same reference point on each clip (clip edge or hole) and space the clips according to the length of each fixture (see figure A). Clip placement: Boca Flasher recommends clips to be installed 1.5" from end cap.
2. Snap in the first light fixture into the clips (see section 2, installing fixtures into clips). Snap the 2nd. light fixture into adjacent clips ensuring that the connections will mate (male to female, see figure B).
3. Slide the second light fixture into the first light fixture until fully seated. (see figure B & 4d).
4. Install #2 lock screw (see figure 4e).
5. **CAUTION DO NOT MATE FIXTURES THAT ARE NOT IN LINE OR FORCE TOGETHER BY WIGGLING. THIS CAN CAUSE PERMANENT DAMAGE TO FIXTURE CONNECTION AND OPERATION.** (see figure B).
6. Continue this process until all light fixtures are installed according to the job specific layout drawings.
7. Connect fixtures to power per section 5 and 6.

FIGURE A: CLIP ALIGNMENT

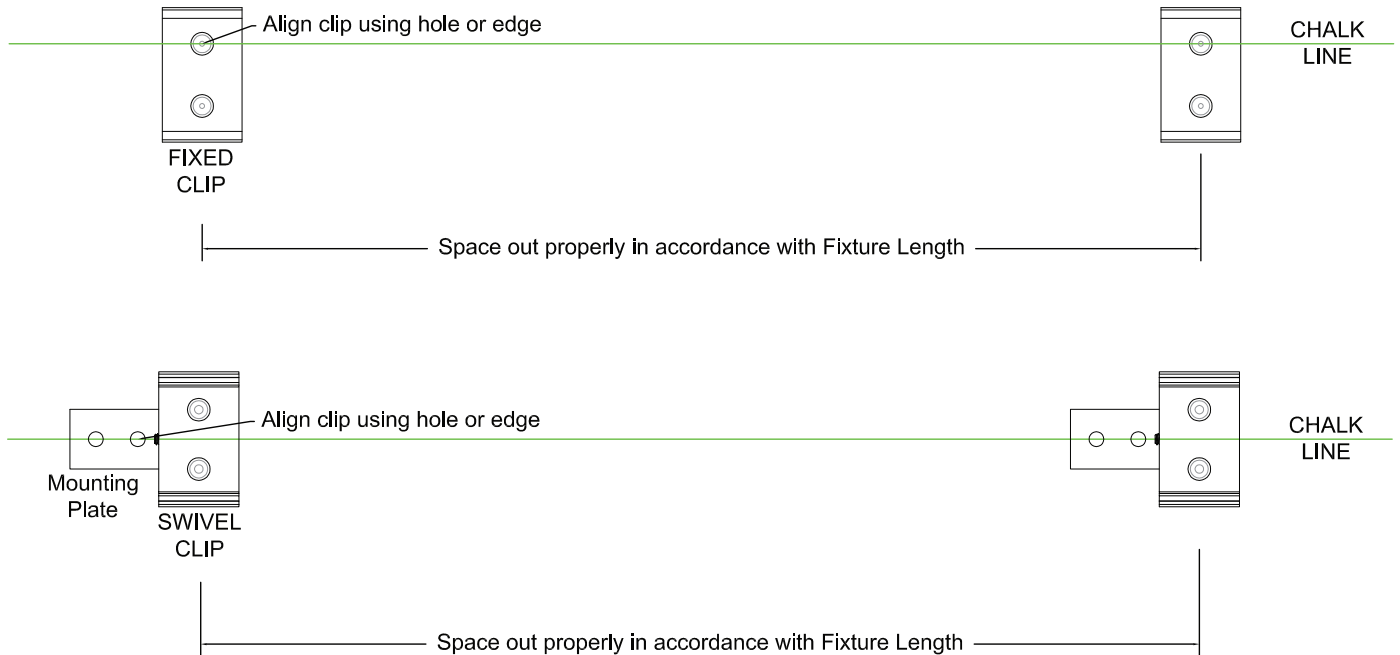

1: INSTALL CLIPS INTO SUBSTRATE

1. Fixed Clips

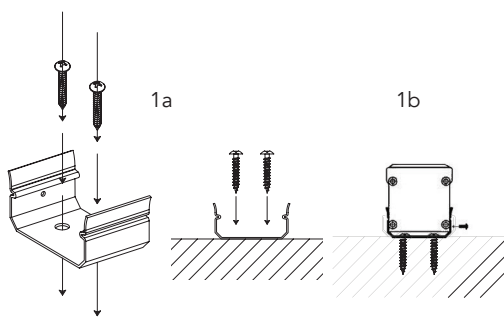

2. Swivel Clips

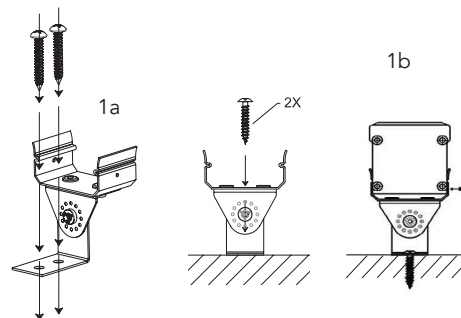

Locking Swivel Bracket:

1. Boca Flasher recommends using an off set Philips screw driver with a #2 bit.
2. Screwdriver should be capable of making a 90° bend.

Screw Information:

1. Screws not provided by Boca Flasher.
2. Boca Flasher recommends wide washer flat head Philips #8 screw (not to exceed .418" in diameter).
3. Length of screw will vary depending on mounting surface.
4. For outdoor installations, installer should use a screw with weatherproof coating.

3. 3" Arc and 6" Arc Bracket Installation

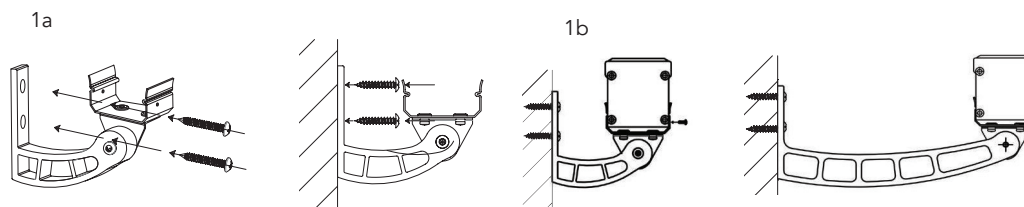

2. INSTALL FIXTURE INTO CLIPS

*For vertical installation, please contact the factory for specific mounting instructions.

2a Place the notch on the clip into the first notch of the fixture.

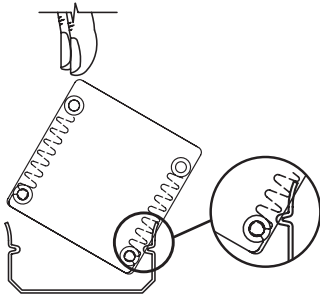

2b Fixture will pivot on notch as it is pushed down.

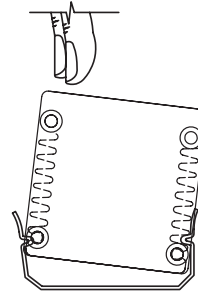

2c Clip will securely snap into place.

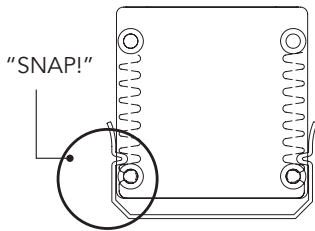

2d If using the Swivel Clip or Arc Bracket loosen the screw where the clip and swivel bracket meet to adjust angle of the fixture.

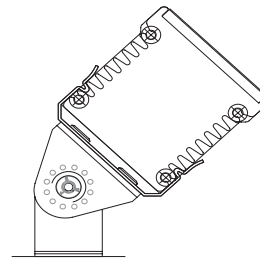

3. CLIP POSITIONING

3a Fixed Mounting Clip

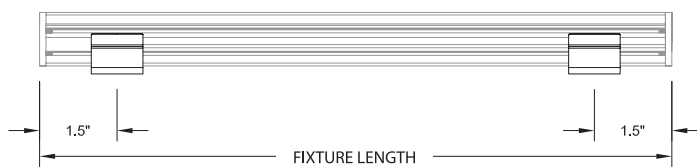

3b Arc Mounting Clip

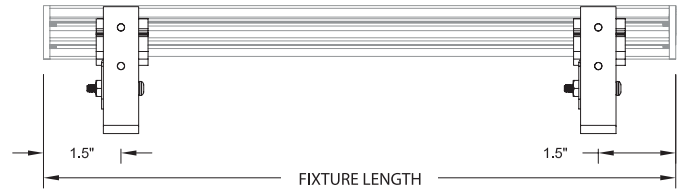

3c Swivel Mounting Clip

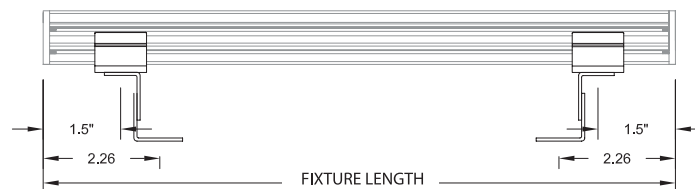

4. CONNECT DMX CABLES TOGETHER (AS SHOWN ON JOB SPECIFIC DRAWING)

4a Rotate fixture to see bottom and note each label.

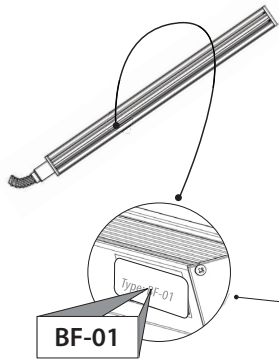

4b Cross-reference with Job Specific Drawing.

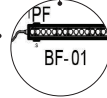
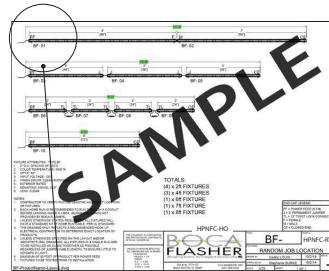

4c Connect Male and Female end caps in order shown on job specific drawings.

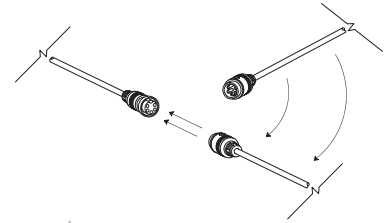

4d Push together until you hear a "CLICK" then twist until secure.

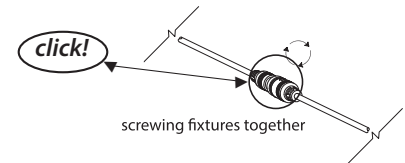

IMPORTANT NOTE: Not screwing fixtures together represents an incomplete install and voids the warranty. If any fixtures are damaged as a result of improper installation

INSTALLATION OF CLIPS FOR LIGHT FIXTURES WITH TWIST LOCK CONNECTIONS:

1. Light fixtures that have twist lock connections on each end may be installed in areas where the surface plane may be at slightly different levels between light fixtures. Also, the light fixtures do not have to be in straight alignment and can be laid out to different angles and patterns.
2. Using a chalk line or laser mark a line on the flat surface where the 2 clips for the 1st. fixture are to be mounted. (See Figure: A)
3. Snap in the first light fixture into the clips (see section 2 installing fixtures into clips).
4. Using a chalk line or laser mark a line on the flat surface where the 2 clips for the 2nd fixture are to be mounted, this fixture can be placed on a slightly different plane as long as the cord between the 2 fixtures is long enough. Also, this fixture can be placed at a different angle than the first fixture (see figure 4).
5. Snap in the 2nd light fixture into the clips (see section 2 installing fixtures into clips).
6. Continue this process until all light fixtures are installed according to the job specific layout drawings.
7. Connect fixtures to power per section 5 and 6.

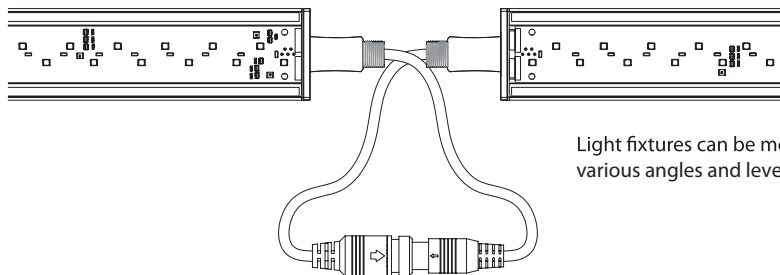

Light fixtures can be mounted at various angles and levels.

5. CONNECT FIXTURES TOGETHER TWIST LOCK CONNECTION

5a See above for information on determining layout.

5b Connect Male and Female twist lock cables in order shown on job specific drawings.

5c Push together and then twist until completely connected and sealed if outdoors.

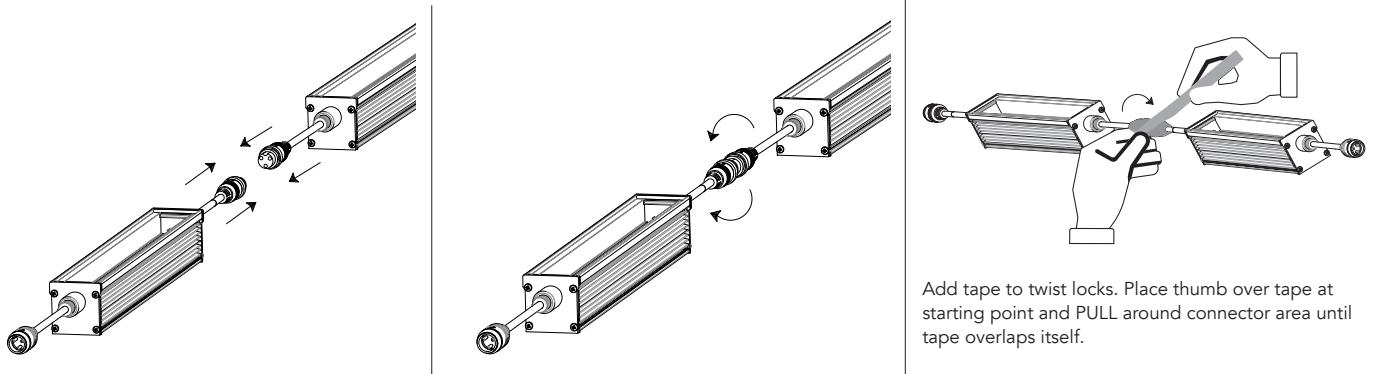

6. CONNECT FIXTURES TO POWER

Cable [LENGHT TO BE DETERMINED] required.
(no purchase necessary)

Note: Runs cannot exceed 8ft per port.

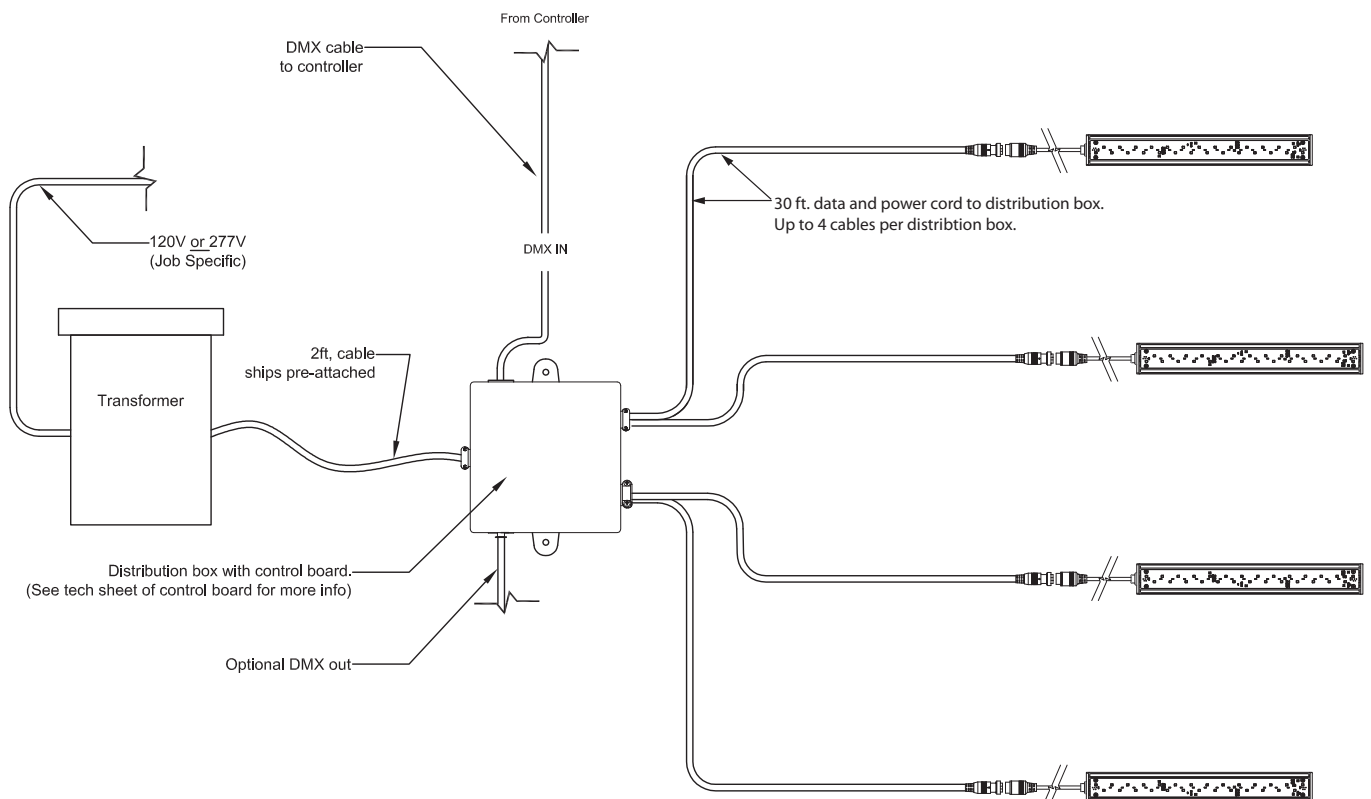

7. REMOVING FIXTURES FROM CLIPS (IF NECESSARY)

7a Slide a flathead screwdriver in between the clip and fixture.

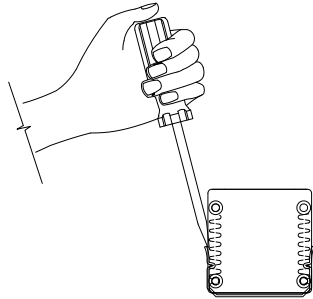

7b While holding the fixture with your other hand, pull back on screwdriver to release from notch.

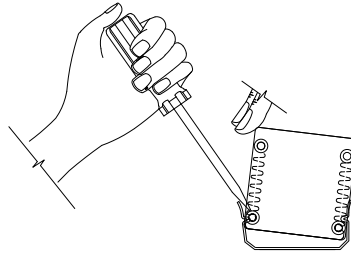

7c Once released from one notch, fixture can be fully removed.

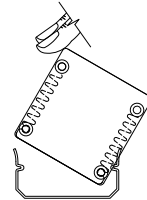

1. DANGER:

To reduce the risk electric shock, always unplug the TRILIGHT from electrical outlet before cleaning. Cut breaker if outlet is not available.

2. To reduce the risk of burns, fire, electric shock or injury to persons:

- Use the TRILIGHT only for its intended use as described in these instructions.
- Do not use attachments not recommended by Boca Flasher.
- Never operate the TRILIGHT if it has a damaged cord, cable or plug, if it is not working properly, if it has been dropped or damaged, or dropped into water. If the seal appears to be damaged/broken/torn return the fixture to a service center for examination or repair.
- Keep cables away from heated surfaces
- Never drop or insert any object into any opening.
- Do not operate where aerosol (spray) products are being used or where oxygen is being administered.

3. WARNING:

- Do not attempt to install or use the TRILIGHT without reading the installation instructions and safety labels.
- Failure to adhere to these instructions could result in serious injury or property damage.

4. Do not modify, alter or attempt to service the TRILIGHT:

- Doing so will void the warranty.

5. There are no serviceable parts within the TRILIGHT:

- Please contact your local representative if issues arise on site during or after installation.

6. Do not use sharp tools near or on the fixture lens:

- Doing so will result in property damage and void the warranty.