



**INTRODUCTION:**

The Boca HPNLS-HO is a line voltage fixture that eliminates the need for secondary transformers, making installation contractor friendly. The housing is anodized aluminum with a durable finish making it weather and abrasion resistant. It is UL Listed for dry, damp or wet location (model dependent). See layout drawings for model provided.

**ELECTRICAL SPECIFICATIONS:**

1. Input Voltage: 90-120VAC or 220-277VAC
2. Total linear ft per 20A breaker: 6wplf), (3wplf)
3. Total linear ft per 15A breaker: 6wplf), (3wplf)

Fixtures must be installed by a qualified and licensed electrician in accordance with all national, state and local electrical codes and regulations. If any part of this manual does not meet the necessary codes and regulations, contact the factory for more information before attempting to install.

**MAINTENANCE:**

**Storage:**

Store in a dry, well-ventilated area when product is not in use. Keep the electrical cord away from heated surfaces when in use or not in use. If cord shows signs of damage do not use, return product to manufacturer.

**Cleaning:**

Interior (IP50) Rated Fixtures:  
To clean surface use a soft damp cloth.

Exterior (IP67) Rated Fixtures:  
To clean surface use a soft cloth with mild soap and water.

**WARNING: DO NOT LIFT FIXTURE BY CABLES. Do not attempt to install or use the HPNLS-HO fixture without reading the installation instructions and safety labels completely.**  
This could result in permanent damage to both the fixture and the cables. Damage resulting from grasping cables and/or putting undue pressure on the cable connections will not be covered under the warranty!  
**FAILURE TO ADHERE TO THESE INSTRUCTIONS COULD RESULT IN SERIOUS INJURY OR PROPERTY DAMAGE. DO NOT MODIFY, ALTER OR ATTEMPT TO SERVICE THE HPNLS-HO DOING SO WILL VOID THE WARRANTY.**



**2. INSTALL FIXTURE INTO CLIPS**

**2a** Place the notch on the clip into the first notch of the fixture.

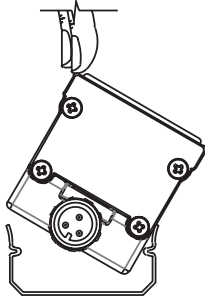

**2b** Fixture will pivot on notch as it is pushed down.

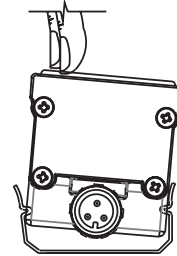

**2c** Clip will securely snap into place.

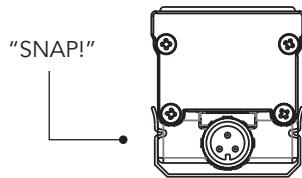

**2d** If using the Swivel Clip or Arc Bracket loosen the screw where the clip and swivel bracket meet to adjust angle of the fixture.

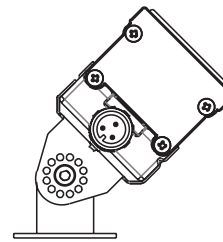

**3A. CONNECT FIXTURES TOGETHER RIGID CONNECTION**

**3a** Rotate fixture to see bottom and note each label.

Labels on fixtures correspond with nomenclatures on drawings.

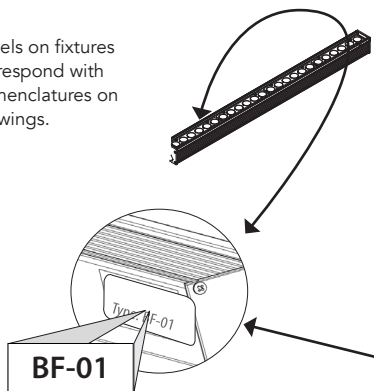

**3b** Cross-reference with Job Specific Drawing.

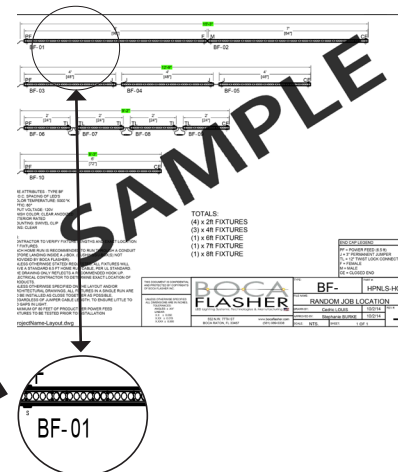

**IMPORTANT NOTE:** Not screwing fixtures together represents an incomplete install and voids the warranty if any fixtures are damaged as a result of improper installation

**3B. CONNECT FIXTURES TOGETHER**

**3a** See above for information on determining layout.

**3b** Connect Male and Female cables in order shown on job specific drawings.

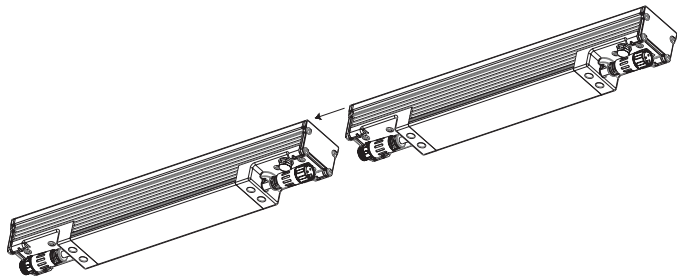

**3c** Push together until you hear a "CLICK"

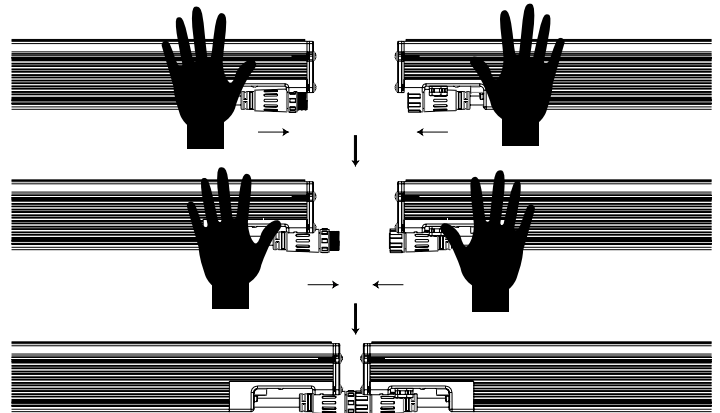

**4. CONNECT FIXTURES TO POWER**

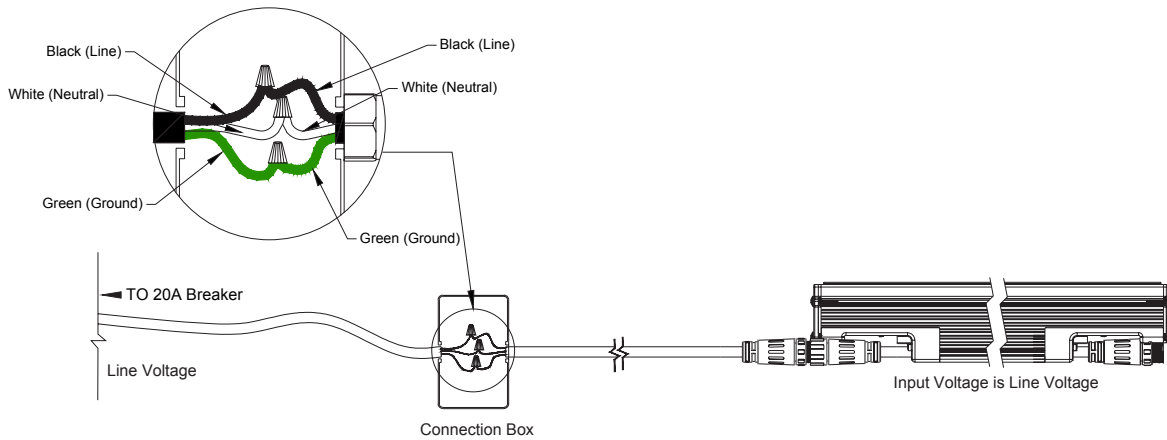

**5. CONNECT FIXTURES TO DIMMING SYSTEM**

\*Note: These fixtures can dim on forward (leading) or reverse (trailing) phase dimmers. Boca Flasher does not recommend the use of a "Smart" or phase-adaptive dimming module.

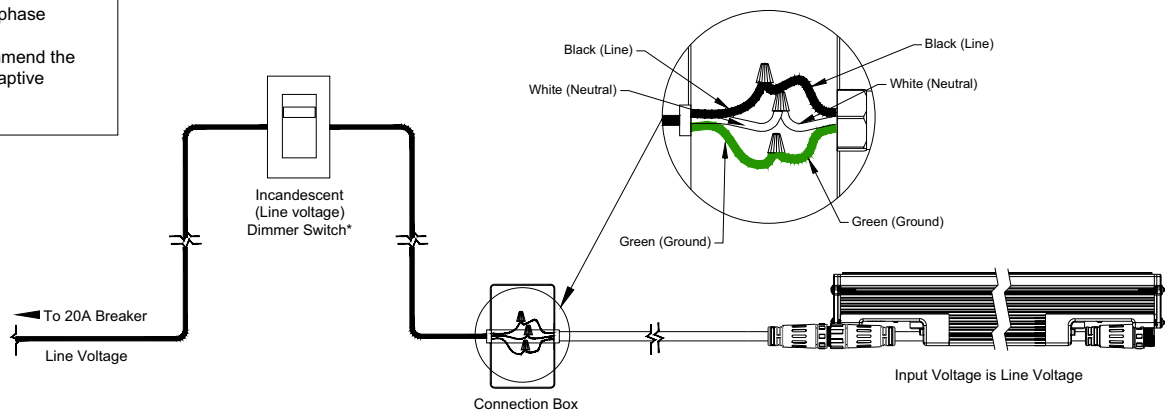

**6. REMOVING FIXTURES FROM CLIPS**

**6a** Slide a flathead screwdriver in between the clip and fixture.

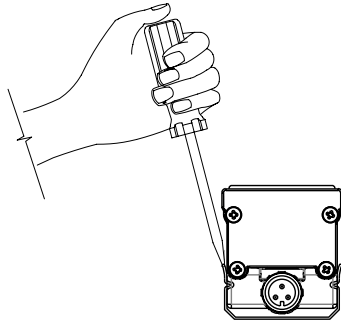

**6b** While holding fixture with other hand, pull back on screwdriver to release from notch.

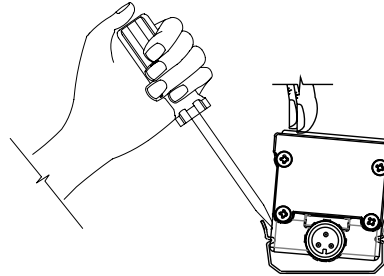

**6c** Once released from one notch, fixture can be fully removed.

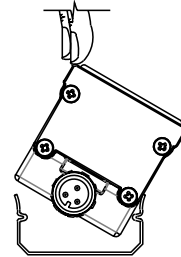

**1. DANGER:**

To reduce the risk electric shock, always unplug the HPNLS-HO from electrical outlet before cleaning. Cut breaker if outlet is not available.

**2. To reduce the risk of burns, fire, electric shock or injury to persons:**

- Use the HPNLS-HO only for its intended use as described in these instructions.
- Do not use attachments not recommended by Boca Lighting and Controls.
- Never operate the HPNLS-HO if it has a damaged cord, cable or plug, if it is not working properly, if it has been dropped or damaged, or dropped into water. If the seal appears to be damaged/broken/torn return the fixture to a service center for examination or repair.
- Keep cables away from heated surfaces
- Never drop or insert any object into any opening.
- Do not operate where aerosol (spray) products are being used or where oxygen is being administered.

**3. WARNING:**

- Do not attempt to install or use the HPNLS-HO without reading the installation instructions and safety labels.
- Failure to adhere to these instructions could result in serious injury or property damage.

**4. Do not modify, alter or attempt to service the HPNLS-HO:**

- Doing so will void the warranty.

**5. There are no serviceable parts within the HPNLS-HO:**

- Please contact your local representative if issues arise on site during or after installation.

**6. Do not use sharp tools near or on the fixture lens:**

- Doing so will result in property damage and void the warranty.