



# HPNLS-LO

Line Voltage Linear LED Strip Fixture

Customer:

Date:

Type:

Project:



- Compact, variable light fixture for dry, damp or wet location use
- Fixture comes in 6" increments (12" minimum).
- Many options in optics, color temperature and accessories.
- Three different types of lenses.
- Boca Flasher's patented CleanDim® technology ensures even dimming from 0-100%.
- Uses standard line voltage dimmers.
- Fixtures are compatible with both forward and reverse phase dimming or can use Boca's SDS module for 0-10V or DMX Dimming.
- Powder coat housing with a durable finish making it weather and abrasion resistant.
- Contact Boca Flasher for tips with custom installations.



## PRODUCT SPECIFICATIONS:

	WATTAGE	COLOR OPTION	OPTIC	VOLTAGE	FINISH	LOCATION	MOUNTING	LENS	OPTIONS
<b>HPNLS</b>									
	LO8 5W/FT	2700K	10°	120V	W White	I Interior-IP50	F Fixed	C Clear	SB Square Baffle
	LO8 8W/FT	3000K	30°	277V	B Black	E Exterior-IP65	H Hinge	D Diffused	ASYM Asymmetric Baffle
	LO8 10W/FT	3500K	60°		G Gray	W Wet-IP68	3Arc 3" Arc Swivel	SI Satin Ice (Interior Use Only)	SKB Kicker Baffle
		4000K	10°x60°				6Arc 6" Arc Swivel	OP Opal White	HL Hexcell Louver (Cannot be used with Satin Ice White or 120° optic)
		5000K	30°x60°				V Vandal Resistant		
		Amber	120°						
		Red							
		Green							
		Blue							

## DIMENSIONS:

- For vertical installation please contact the factory for specific mounting instructions.
- For installations above 4' please contact the factory.

Plan View

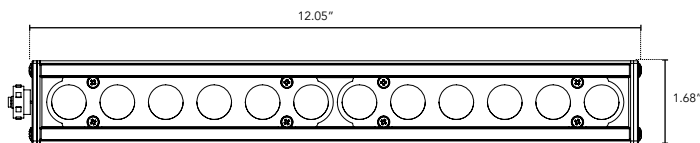

Elevation View

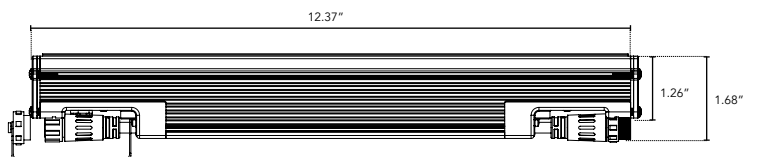

# HPNLS-LO

Line Voltage Linear LED Strip Fixture



## TECHNICAL SPECIFICATIONS:

WATTAGE	5, 8 or 10 watts per linear ft.
INPUT VOLTAGE	90-120V 230-277V
CONTROL	Leading Edge/Trailing Edge line dimmer 0-10V, DMX*
LED SPACING	1.5" on center
LENGTH	12" - 96", 6" increments
TOTAL HEIGHT	1.75" (not including clip)
TOTAL WIDTH	1.68"
COLOR OPTIONS	2700K, 3000K, 3500K, 4000K, 5000K, Amber, Red, Green, Blue
MOUNTING	Fixed, Swivel, Hinge, 3" Arc, 6" Arc or Vandal Resistant
AVAILABLE OPTICS	10°, 30°, 60°, 10° x 60°, 30° x 60°, 120°
RATING	IP50, IP65, IP68
COLOR RENDERING INDEX (CRI)	90 + CRI
POWER CABLE	UL Standard 10 ft.
ENVIRONMENTAL	Operating temperature -40°F-140°F Ambient (-40°C-60°C)** Storage temperature -40°F-140°F Ambient indoor fixtures operation limited to <=50% relative humidity

\*Uses Boca SDS Module for 0-10V, Dali, or DMX Dimming.

\*\* Military spec available under special request-lead times may be impacted.

## LENS OPTIONS:

### Diffused\*

- 87% transmission.
- Lens is 1/8" (.09) thick, adds 1/16" to overall height of fixture.  
Call factory for more information.

\*Additional chargers apply

### Satin Ice White\*

- Best for direct view use.
- 42% transmission.
- Lens is 1/4" (.25) thick, adds 1/8" to overall height of fixture.  
Call factory for more information.

\*Additional chargers apply.

## MOUNTING INFORMATION:

- Fixtures 1-2ft, Place clips 3" from edge as shown.
- Fixtures more than 2ft, Place clips 3.5" from edges as shown.

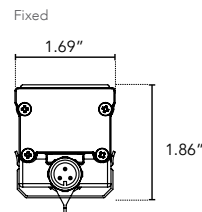
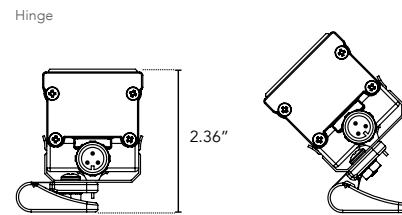
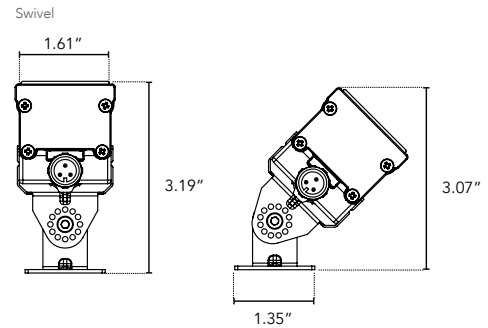

### Vandal Resistant

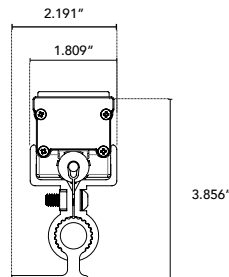

# HPNLS-LO

Line Voltage Linear LED Strip Fixture

## BODY CHOICES:

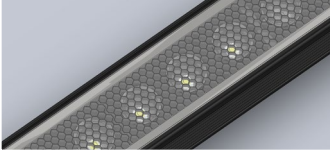

### Hexcell Louver

- Economical solution to off axis glare issues.
- Louver is located flush to secondary optic, preventing unwanted striation.
- Louver cannot be utilized when no optic (120°) is specified.
- Louver is behind lens to ensure no damage is done during installation or after. This also ensures no dust build-up.
- Louver ships pre-fitted making on site fixture installation easy.
- No unsightly clips, screws, or brackets.
- Can be used with other baffles.
- Adds nothing to overall height.
- To specify add "HL" in options box.

\*Additional charges may apply.

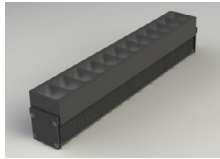

SB - Square Baffle



ASYM - Asymmetric Baffle

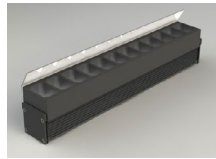

SKB - Sq. Kicker Baffle

### Baffle Square Design

- Design cuts off light at 90°
- Baffles are lightweight black PVC with non-reflective surfaces to avoid glare from interior sections.
- One piece baffle slides onto the extruded housing making installation easy.
- SB only adds .75" to overall height  
ASYM adds .90" to overall height  
SKB adds 1.625" to overall height
- To specify add "SB" or "ASYM" for slanted version or "SKB" for kicker version in options box.

## LUMINAIRE INFORMATION:

LUMENS PER LAMP -3500K 30X60	936 (1 lamp)
TOTAL LAMP LUMENS	936
LUMINAIRE LUMENS	936
TOTAL LUMINAIRE EFFICIENCY	100%
LUMEN EFFICACY RATING	94
TOTAL LUMINAIRE WATTS	10.02
BALLAST FACTOR	1.00
CIE TYPE	Direct
SPACING CRITERION (0-180)	0.58
SPACING CRITERION (90-270)	0.62
SPACING CRITERION (Diagonal)	0.60
BASIC LUMINOUS SHAPE	Rectangular
LUMINOUS LENGTH (0-180)	0.31m
LUMINOUS WIDTH (90-270)	0.04m
LUMINOUS HEIGHT	0.05m

- Lo8 Data - 10W for 6W use 0.65 multiplier
- Specific Files Available On Request